

การไฟฟ้าฝ่ายผลิตแห่งประเทศไทย

**REGISTRATION FORM**

INVITATION TO BID NO. TS12-S-13

FOR SUPPLY AND CONSTRUCTION OF 230/115 kV CHON BURI 2 SUBSTATION (230 kV GIS),  
EXPANSION OF 230 kV BO WIN SUBSTATION, AND IMPROVEMENT OF 230 kV AO PHAI AND 230 kV PHAN THONG SUBSTATIONS  
TRANSMISSION SYSTEM EXPANSION PROJECT NO. 12

AVAILABLE DURATION FOR PURCHASING May 22, 2019 TO June 28, 2019

PRICE USD 256.- OR THB 8,000.-

**COMPLETE DATA IS REQUIRED FOR THE BIDDER'S OWN BENEFITS**

(โปรดกรอกรายละเอียดให้ครบถ้วนเพื่อประโยชน์ของบริษัท)

**Step 1** : Fill out this Registration Form in English (Typing is preferred)

**Step 2** : Submit this form for payment at Receivable Cashier Section (1<sup>st</sup> Floor, TOR 100 Bldg., Counter 4-8) Tel no. 02 436 5512

**Step 3** : Bring the payment receipt and the copy of filled-out Registration Form to receive the bidding documents at International Procurement Department - Transmission Segment (Room No. 1202/2, 12<sup>th</sup> Floor, Building Tor. 101) Tel no. 02 436 0241-42

FOR PURCHASER			TAX ID :
NO.	RECEIPT NO. :	DATE :	PURCHASER (ผู้ซื้อ):
BIDDER'S NAME (บริษัทผู้ซื้อเอกสาร)			
ADDRESS (ที่อยู่)		COUNTRY :	
ATTN. (ผู้รับผิดชอบ):		FAX NO.:	TEL.:
E-mail :			
LOCAL REPRESENTATIVE (ตัวแทนในประเทศ)			
ADDRESS (ที่อยู่)		TAX ID :	
ATTN. (ผู้รับผิดชอบ):		FAX NO.:	TEL.:
E-mail :			
FOR PROCUREMENT OFFICER		CHANGE OF BIDDER'S NAME	TAX ID :
NEW BIDDER'S NAME (ชื่อผู้ซื้อเอกสารเปลี่ยนเป็น)			
ADDRESS (ที่อยู่)		COUNTRY :	
ATTN. (ผู้รับผิดชอบ):		FAX NO.:	TEL.:
E-mail :			
LOCAL REPRESENTATIVE (ตัวแทนในประเทศ)			
ADDRESS (ที่อยู่)		TAX ID :	
ATTN. (ผู้รับผิดชอบ):		FAX NO.:	TEL.:
E-mail :			
FOR PROCUREMENT OFFICER		FOR PURCHASER	
Procurement Officer (ผู้ส่งมอบเอกสาร)		Document received by (ผู้รับมอบเอกสาร)	



INVITATION TO BID NO. TS12-S-13

(Revision 2)

SUPPLY AND CONSTRUCTION OF 230/115 KV CHON BURI 2 SUBSTATION (230 KV GIS),  
EXPANSION OF 230 KV BO WIN SUBSTATION,  
AND IMPROVEMENT OF 230 KV AO PHAI AND 230 KV PHAN THONG SUBSTATIONS  
TRANSMISSION SYSTEM EXPANSION PROJECT NO. 12  
(TWO ENVELOPE)

The Electricity Generating Authority of Thailand (EGAT) is calling for the subject Invitation to Bid to be financed by EGAT's fund. The escalation factor (K) for price adjustment is applied to this Bid.

**Place of Construction** : Chon Buri 2 Substation, Bo Win Substation, Ao Phai Substation and Phan Thong Substation

**Medium Cost (including Value Added Tax and other expenses)** : THB 785,000,000.-

**Eligibility of Bidders**

1. The Bidder shall be a juristic person who provides such services and shall not be named in the List of Work Abandoners published by the Office of Prime Minister and/or in the Debarment List and/or in the List of Work Abandoners declared by EGAT.
2. The Bidder shall not be a Jointly Interested Bidder with other Bidders as from the date of EGAT's issuance of the Invitation, or shall not be a person who undertakes any action as an "Obstruction of Fair Price Competition" for this Invitation.
3. The Bidder shall not either be EGAT's consultant or involve in EGAT's consultancy company under this Invitation to Bid, or shall not have EGAT's personnel involved in his business as shareholder having voting right that can control his business, director, manager, officer, employee, agent, or consultant except those who are officially ordered by EGAT to act or participate therein.
4. The Bidder shall not be the person who is privileged or protected not to be taken any legal proceedings under Thai Court; Provided that such Bidder's government declares that such special privilege is waived.
5. The Bidder who is a joint venture or consortium shall carry out all the work under such formation from the time of bidding until the fulfillment of the Contract.

**Availability of Bidding Documents**

Bidding Documents in CD-ROM will be available for examination of Bidder's Qualifications and purchase during 8:00 hrs. to 15:00 hrs., Bangkok Standard Time, as from May 22, 2019 to June 28, 2019 at USD 256.- or THB 8,000.- per copy, non-refundable, at the following address :

International Procurement Department - Transmission Segment  
(Room No. 1202/2, 12<sup>th</sup> Floor, Building Tor. 101)  
Procurement and Inventory Management Division  
Electricity Generating Authority of Thailand  
Bangkruai, Nonthaburi 11130, Thailand  
Telephone no. 66 2436 0242  
E-mail : [procurement.tse@egat.co.th](mailto:procurement.tse@egat.co.th)

Nilanate Osotpanapust

For more details and downloading Registration Form for purchasing Bidding Documents on website : <http://www4.egat.co.th/fprocurement/biddingeng/>

Payment can be made by a certified cheque or money order payable to EGAT or by a telegraphic transfer to EGAT's current account no. 109-6-01958-2 (swift code : KRTHTHBK), Krung Thai Bank Public Company Limited, Bangkruai Branch, Nonthaburi. All bank charges and fees incurred by the payment of bidding documents shall be under the buyer's responsibility.

Bidding Documents in CD-ROM will be either airmailed or airfreighted to the buyer at EGAT's expense upon receipt of the relevant remittance. In case the buyer requires the Bidding Documents to be sent by Express Mail Service (EMS), the charge will be at the buyer's expense.

**\*Delivery of Bids**

Price and Technical Proposals shall be submitted at Room No. 1202/1, 12<sup>th</sup> Floor, Building Tor. 101 during 9:30 hrs. to 10:00 hrs., Bangkok Standard Time, **August 21, 2019** and Technical Proposal will be opened publicly at 10:00 hrs.

ELECTRICITY GENERATING AUTHORITY OF THAILAND

*August 9, 2019*

*Nilanate Osotpavapust*

(Mrs. Nilanate Osotpavapust)

Chief, International Procurement Department - Transmission Segment

*Remarks : Price and Technical Proposal Submission Date and Technical Proposals Opening Date is postponed from August 1, 2019 to August 21, 2019.*



ประกาศการไฟฟ้าฝ่ายผลิตแห่งประเทศไทย  
เรื่อง ประกวดราคาจ้าง เลขที่ TS12-S-13  
(ประกวดราคา 2 ของ)

(ฉบับแก้ไข ครั้งที่ 2)

การไฟฟ้าฝ่ายผลิตแห่งประเทศไทย (กฟผ.) มีความประสงค์จะจัดหาและจ้างก่อสร้างสถานีไฟฟ้าแรงสูง 230/115 KV ชลบุรี 2 (230 KV GIS) และจัดหาและจ้างก่อสร้างขยายลานโกของสถานีไฟฟ้าแรงสูง 230 KV บ่อวิน และจัดหาและจ้างก่อสร้างปรับปรุงสถานีไฟฟ้าแรงสูง 230 KV อ่าวไผ่ และ 230 KV พานทอง สำหรับโครงการขยายระบบส่งไฟฟ้าระยะที่ 12 โดยทำสัญญาแบบปรับราคาได้ (ค่า k) โดยใช้งบประมาณ กฟผ.

**สถานที่ก่อสร้าง :** สถานีไฟฟ้าแรงสูงชลบุรี 2 สถานีไฟฟ้าแรงสูงบ่อวิน สถานีไฟฟ้าแรงสูงอ่าวไผ่ และสถานีไฟฟ้าแรงสูงพานทอง

**ราคากลาง (รวมภาษีมูลค่าเพิ่มและค่าใช้จ่ายอื่นๆ) :** 785,000,000.- บาท

**คุณสมบัติของผู้เสนอราคา**

1. ต้องเป็นนิติบุคคลผู้มีอาชีพรับจ้างตามประกวดราคาจ้างดังกล่าว และต้องไม่เป็นผู้ทำงานซึ่งสำนักนายกรัฐมนตรีได้แจ้งเวียนชื่อไว้ หรือต้องไม่เป็นผู้ที่ กฟผ. ห้ามติดต่อหรือห้ามเข้าเสนอราคา หรือต้องไม่เป็นผู้ที่ได้รับผลของการสั่งให้นิติบุคคลหรือบุคคลอื่นเป็นผู้ทำงานตามคำสั่ง กฟผ.
2. ต้องไม่เป็นผู้มีผลประโยชน์ร่วมกันกับผู้เสนอราคารายอื่น ณ วันประกาศประกวดราคาครั้งนี้เป็นต้นไป หรือต้องไม่เป็นผู้กระทำการอันเป็นการขัดขวางการแข่งขันราคาอย่างเป็นธรรมในการดำเนินการประกวดราคาครั้งนี้
3. ต้องไม่เป็นที่ปรึกษาของ กฟผ. หรือมีส่วนร่วมในบริษัทที่ปรึกษาของ กฟผ. ในงานนี้ หรือต้องไม่มีผู้ปฏิบัติงาน กฟผ. เข้าไปมีส่วนร่วมในกิจการของผู้เสนอราคา ไม่ว่าจะในฐานะผู้ถือหุ้นที่มีสิทธิควบคุมการจัดการ กรรมการ ผู้อำนวยการ ผู้จัดการ พนักงาน ลูกจ้าง ตัวแทน หรือที่ปรึกษา ยกเว้น ในกรณีที่ผู้ปฏิบัติงานได้รับคำสั่งอย่างเป็นทางการจาก กฟผ. ให้ไปปฏิบัติงานหรือเข้าร่วมในกิจการของผู้เสนอราคา
4. ต้องไม่เป็นผู้ได้รับเอกสิทธิ์หรือความคุ้มกัน ซึ่งอาจปฏิเสธไม่ยอมขึ้นศาลไทย เว้นแต่รัฐบาลของผู้เสนอราคาได้มีคำสั่งให้สละสิทธิ์และความคุ้มกันเช่นนั้น .
5. ผู้ประสงค์เข้าประกวดราคาในนามของกิจการร่วมค้าหรือกิจการค้าร่วม (Joint Venture or Consortium) จะต้องดำเนินการทุกขั้นตอนของการประกวดราคาในนามของกิจการร่วมค้าหรือกิจการค้าร่วม ตั้งแต่การเสนอราคาจนสิ้นสุดข้อผูกพันกับ กฟผ.

ศิวรักษ์ โสภณกุลมา

**การขายเอกสารประกวดราคา**

ผู้สนใจติดต่อขอทราบรายละเอียด เพื่อตรวจสอบคุณสมบัติของผู้เสนอราคา และขอซื้อเอกสารประกวดราคา ในราคาชุดละ 8,000.- บาท ได้ที่แผนกจัดจ้างต่างประเทศสายงานระบบส่ง (ห้อง 1202/2 ชั้น 12 อาคาร ท.101) กองจัดซื้อจัดจ้าง ต่างประเทศสายงานระบบส่ง ฝ่ายจัดซื้อจัดจ้างและบริหารพัสดุ การไฟฟ้าฝ่ายผลิตแห่งประเทศไทย เชียงสะพานพระราม 7 จังหวัดนนทบุรี ในวันทำการระหว่างเวลา 08:00 น. ถึง 15:00 น. ตั้งแต่วันที่ 22 พฤษภาคม 2562 ถึงวันที่ 28 มิถุนายน 2562 หรือสอบถามทาง โทรศัพท์ หมายเลข 0 2436 0242 หรืออีเมล procurement.tse@egat.co.th ทั้งนี้ สามารถ download แบบฟอร์มลงทะเบียน ผู้ซื้อเอกสารประกวดราคาได้ที่เว็บไซต์ <http://www4.egat.co.th/fprocurement/biddingeng/>

**\*การยื่นซองประกวดราคา**

กำหนดยื่นซองข้อเสนอด้านเทคนิคพร้อมซองราคา ในวันที่ 21 สิงหาคม 2562 เวลา 9:30 น. ถึง 10:00 น. และ เปิดซองข้อเสนอด้านเทคนิคเวลา 10:00 น. ณ ห้อง 1202/1 ชั้น 12 อาคาร ท.101 การไฟฟ้าฝ่ายผลิตแห่งประเทศไทย เชียงสะพานพระราม 7 จังหวัดนนทบุรี

ประกาศฉบับแก้ไข ณ วันที่ 9 สิงหาคม 2562

ผิงหน โอลงอภิม

(นางนิลเนตร โอลงอภิม)

หัวหน้ากองจัดซื้อจัดจ้างต่างประเทศสายงานระบบส่ง

หมายเหตุ : เลื่อนกำหนดยื่นซองข้อเสนอด้านเทคนิคพร้อมซองราคาและเปิดซองข้อเสนอด้านเทคนิคจากวันที่

1 สิงหาคม 2562 เป็นวันที่ 21 สิงหาคม 2562

**ตารางแสดงวงเงินงบประมาณที่ได้รับจัดสรรและราคากลาง(ราคาอ้างอิง)  
ในการจัดซื้อจัดจ้างที่มีชิ้นงานก่อสร้าง**

1. **ชื่อโครงการ** ประกวดราคาเลขที่ TS12-S-13  
งานจัดหาและจ้างก่อสร้างสถานีไฟฟ้าแรงสูง 230/115 kV ชลบุรี 2 (230 kV GIS)  
และจัดหาและจ้างก่อสร้างขยายลานโกของสถานีไฟฟ้าแรงสูง 230 kV บ่อวิน  
และจัดหาและจ้างก่อสร้างปรับปรุงสถานีไฟฟ้าแรงสูง 230 kV อ่าวไม้ และ 230 kV พานทอง  
โครงการขยายระบบส่งไฟฟ้าระยะที่ 12  
/หน่วยงานเจ้าของโครงการ ฝ่ายแผนงานและโครงการระบบส่ง การไฟฟ้าฝ่ายผลิตแห่งประเทศไทย
2. **วงเงินงบประมาณที่ได้รับจัดสรร**  
โครงการขยายระบบส่งไฟฟ้าระยะที่ 12 งบประมาณ 60,000 ล้านบาท
3. **วันที่กำหนดราคากลาง** 17 เมษายน 2562 (วันที่ รวส. อนุมัติ )  
ราคารวมภาษีมูลค่าเพิ่มและค่าใช้จ่ายอื่นๆ เป็นเงิน 785,000,000.00 บาท ราคา/หน่วย ตามเอกสารแนบ
4. **แหล่งที่มาของราคากลาง**  
หลักเกณฑ์การกำหนดราคากลางการจัดซื้อและจัดจ้างงานก่อสร้างระบบส่งไฟฟ้าของสายงานระบบส่ง
5. **รายชื่อเจ้าหน้าที่ผู้กำหนดราคากลาง**
  - 5.1 นายฉัตรชัย เซวนาธิคม หมฟ-ส. กวอ-ส.
  - 5.2 นายธิติวัดน์ เบญจวงศ์รัตน์ หสก-ส. กวอ-ส.
  - 5.3 นายภาณุวัฒน์ ลิขิตผลผดุง หอต-ส. กวอ-ส.
  - 5.4 นายสุริยะ ประงษ์วิญเมือง หวอ-ส. กวอ-ส.
  - 5.5 นายเมธา รักปาน กวป-ส.
  - 5.6 นางอุบลรัตน์ ต้นเกต กวส-ส. อรส.
  - 5.7 นางรัมภา สุนทรินทุ กวธ-ส.

**หมายเหตุ** ค่าใช้จ่ายอื่นๆ ได้แก่ ค่าใช้จ่ายที่ กฟผ. ต้องจ่ายตามวิธีการพิจารณาเปรียบเทียบราคาที่กำหนดไว้ในเอกสารประกวดราคา เช่น อากรขาเข้า เป็นต้น

  
**นางสาววัลลภา ชิวณานกรณ์กุล**  
หจตส-ท.

15 พ.ค. 2562

**MEDIUM COST FOR BID NO. TS12-S-13**  
**SUMMARY OF BID PRICE**  
**SUPPLY AND CONSTRUCTION OF 230/115 kV CHON BURI 2 SUBSTATION (230 kV GIS), EXPANSION OF 230 kV BO WIN SUBSTATION**  
**, AND IMPROVEMENT OF 230 kV AO PHAI AND 230 kV PHAN THONG SUBSTATIONS**  
**TRANSMISSION SYSTEM EXPANSION PROJECT NO. 12**

Schedule	Description	Currency	Supply of Equipment		Local Currency (excluding VAT) Baht Amount	Local Transportation (excluding VAT) Baht Amount	Local Transportation, Construction and Installation (excluding VAT) Baht Amount
			Foreign Supply	Local Supply			
			CIF Thai Port	Ex-works Price (excluding VAT) Baht			
			Amount	Amount			
1	230/115 kV CHON BURI 2 SUBSTATION (230 kV GIS)	THB	305,701,328.59	96,217,447.37	176,524,998.48	384,831.31	54,162,079.59
2	230 kV BO WIN SUBSTATION	THB	12,576,256.34	32,418,462.63	30,924,147.91	14,388.12	10,208,361.46
3	230 kV AO PHAI SUBSTATION			658,858.00			563,950.00
4	230 kV PHAN THONG SUBSTATION			5,719,825.00			1,406,560.50
<b>BID PRICE</b>		THB	318,277,584.93	Baht 135,014,593.00	Baht 207,449,146.39	Baht 399,219.43	Baht 66,332,951.55
<b>OTHER EXPENSES</b>		THB	6,368,551.70	XXXXX	XXXXX	XXXXX	
<b>VAT</b>		THB	22,725,019.56	Baht 9,451,021.51	Baht 14,521,440.25	Baht 27,945.36	Baht 4,643,306.61
<b>SUMMARY OF BID PRICE</b>		THB	347,368,156.19	Baht 144,465,614.51	Baht 221,970,586.64	Baht 427,164.79	Baht 70,976,258.16
<b>TOTAL MEDIUM COST</b>		THB	785,207,780.29				
<b>TOTAL MEDIUM COST (ROUNDED)</b>		THB	785,000,000.00				

Schedule 1, 2, 3, and 4 are related schedules referring to Article F-15. Liquidated Damages for Late Completion and Late Delivery, item a. For Complete Construction of Substation.

## MEDIUM COST FOR BID NO. TS12-S-13

## SCHEDULE 1 : 230/115 KV CHON BURI 2 SUBSTATION (230 KV GIS)

## SUPPLY AND CONSTRUCTION OF 230/115 KV CHON BURI 2 SUBSTATION (230 KV GIS), EXPANSION OF 230 KV BO WIN SUBSTATION, AND IMPROVEMENT OF 230 KV AO PHAI AND 230 KV PHAN THONG SUBSTATIONS

## TRANSMISSION SYSTEM EXPANSION PROJECT NO. 12

Description	Currency	Supply of Equipment		Local Currency (excluding VAT) Baht Amount	Local Transportation (excluding VAT) Baht Amount	Local Transportation, Construction and Installation (excluding VAT) Baht Amount
		Foreign Supply	Local Supply			
		CIF Thai Port	Ex-works Price (excluding VAT) Baht			
		Amount	Amount			
PART IAB : SUPPLY AND INSTALLATION OF SUBSTATION EQUIPMENT	THB	300,999,363.19	93,222,557.37			54,162,079.59
PART 1C : CIVIL WORK				176,524,998.48		
PART 1D : SUPPLY OF SPARE PARTS	THB	4,701,965.40	2,994,890.00		384,831.31	
<b>TOTAL PRICE</b>	<b>THB</b>	<b>305,701,328.59</b>	<b>Baht</b>	<b>Baht</b>	<b>Baht</b>	<b>Baht</b>
			<b>96,217,447.37</b>	<b>176,524,998.48</b>	<b>384,831.31</b>	<b>54,162,079.59</b>

นางสาววัลลภา ชีวนากรณ์กุล



## MEDIUM COST FOR BID NO. TS12-S-13

## PART 1AB : SUPPLY AND INSTALLATION OF SUBSTATION EQUIPMENT

## SUPPLY AND CONSTRUCTION OF 230/115 KV CHON BURI 2 SUBSTATION (230 KV GIS), EXPANSION OF 230 KV BO WIN SUBSTATION, AND IMPROVEMENT OF 230 KV AO PHAI AND 230 KV PHAN THONG SUBSTATIONS

## TRANSMISSION SYSTEM EXPANSION PROJECT NO. 12

Description	Currency	Supply of Equipment		Local Transportation, Construction and Installation (excluding VAT) Baht
		Foreign Supply	Local Supply	
		CIF Thai Port	Ex-works Price (excluding VAT) Baht	
		Amount	Amount	
Schedule 1AB1 : Power Transformer and Marshalling Control Cubicle			234,000.00	23,400.00
Schedule 1AB2 : Distribution Transformer			995,000.00	99,500.00
Schedule 1AB4 : Surge Arrester	THB	2,250,000.00	508,550.40	275,855.04
Schedule 1AB5 : Current Transformer and Junction Box	THB	2,970,000.00	541,275.20	351,127.52

## MEDIUM COST FOR BID NO. TS12-S-13

## PART 1AB : SUPPLY AND INSTALLATION OF SUBSTATION EQUIPMENT

## SUPPLY AND CONSTRUCTION OF 230/115 KV CHON BURI 2 SUBSTATION (230 KV GIS), EXPANSION OF 230 KV BO WIN SUBSTATION, AND IMPROVEMENT OF 230 KV AO PHAI AND 230 KV PHAN THONG SUBSTATIONS

## TRANSMISSION SYSTEM EXPANSION PROJECT NO. 12

Description	Currency	Supply of Equipment		Local Transportation, Construction and Installation (excluding VAT ) Baht Amount
		Foreign Supply	Local Supply	
		CIF Thai Port	Ex-works Price (excluding VAT ) Baht	
		Amount	Amount	
Schedule 1AB6 : Coupling Capacitor Voltage Transformer, Coupling Capacitor, Voltage Transformer and Junction Box	THB	5,348,100.00	754,152.60	610,225.26
Schedule 1AB7 : SF6 Gas Insulated Switchgear	THB	283,164,420.00		28,316,442.00
Schedule 1AB9 : Power Circuit Breaker	THB	1,722,600.00	86,750.40	180,935.04

นางสาววัลลภา ชิวชนากรณ์กุล

ทจตส-ท.

15 พ.ค. 2562

## MEDIUM COST FOR BID NO. TS12-S-13

## PART 1AB : SUPPLY AND INSTALLATION OF SUBSTATION EQUIPMENT

## SUPPLY AND CONSTRUCTION OF 230/115 KV CHON BURI 2 SUBSTATION (230 KV GIS), EXPANSION OF 230 KV BO WIN SUBSTATION, AND IMPROVEMENT OF 230 KV AO PHAI AND 230 KV PHAN THONG SUBSTATIONS

## TRANSMISSION SYSTEM EXPANSION PROJECT NO. 12

Description	Currency	Supply of Equipment		Local Transportation, Construction and Installation (excluding VAT) Baht
		Foreign Supply	Local Supply	
		CIF Thai Port	Ex-works Price (excluding VAT) Baht	
		Amount	Amount	
Schedule 1AB10 : Disconnecting Switch	THB	996,600.00	355,027.20	135,162.72
Schedule 1AB11 : Power Fuse, Fuse Link and Hook Stick	THB	497,708.20		49,770.82
Schedule 1AB12 : AC&DC Distribution Board and Termination Box			2,247,764.00	224,776.40
Schedule 1AB13 : Stationary Battery and Battery Charger	THB	1,855,700.00	1,578,735.43	334,510.00

นางสาววัลลภา ชีวนากรณ์กุล  
ทจตส-ท.

**MEDIUM COST FOR BID NO. TS12-S-13**

**PART 1AB : SUPPLY AND INSTALLATION OF SUBSTATION EQUIPMENT**

**SUPPLY AND CONSTRUCTION OF 230/115 KV CHON BURI 2 SUBSTATION (230 KV GIS), EXPANSION OF 230 KV BO WIN SUBSTATION, AND IMPROVEMENT OF 230 KV AO PHAI AND 230 KV PHAN THONG SUBSTATIONS**

**TRANSMISSION SYSTEM EXPANSION PROJECT NO. 12**

Description	Currency	Supply of Equipment		Local Transportation, Construction and Installation (excluding VAT) Baht
		Foreign Supply	Local Supply	
		CIF Thai Port	Ex-works Price (excluding VAT) Baht	
		Amount	Amount	
Schedule 1AB14 : Substation Steel Structure			10,048,744.16	2,134,035.01
Schedule 1AB15 : Insulator				230,898.53
Schedule 1AB18 : Low Voltage Cable and Conductor			41,545,711.90	10,386,427.98
Schedule 1AB19 : Switchyard Lighting Fixtures			1,727,480.70	431,870.18

นางสาววัลลภา ชีวนากรณ์กุล  
 ทัศน-น.

นางสาวพนา สุทธิกุล  
 18 เมษายน 67  
 filename : TS12-S-13-1 (230,115 kV CB2)

MEDIUM COST FOR BID NO. TS12-S-13

PART 1AB : SUPPLY AND INSTALLATION OF SUBSTATION EQUIPMENT

SUPPLY AND CONSTRUCTION OF 230/115 KV CHON BURI 2 SUBSTATION (230 KV GIS), EXPANSION OF 230 KV BO WIN SUBSTATION, AND IMPROVEMENT OF 230 KV AO PHAI AND 230 KV PHAN THONG SUBSTATIONS

TRANSMISSION SYSTEM EXPANSION PROJECT NO. 12

Description	Currency	Supply of Equipment		Local Transportation, Construction and Installation (excluding VAT) Baht
		Foreign Supply	Local Supply	
		CIF Thai Port	Ex-works Price (excluding VAT) Baht	
		Amount	Amount	
Schedule 1AB20 : Aluminum Tube, Connector and Miscellaneous Hardware			445,687.01	111,421.75
Schedule 1AB21 : Bus Fitting	THB	597,613.03		149,403.26
Schedule 1AB22 : Grounding Material	THB	1,460,743.90	1,434,542.19	723,821.52
Schedule 1AB23 : Substation Miscellaneous	THB	135,878.06	713,536.18	212,353.56

นางสาววัลลภา ชีวชนากรณ์กุล  
ทจตส-พ.

นางสาวพนา สุภาภักดิ์  
ทจตส-พ.  
วันที่ 18/12/2562

**MEDIUM COST FOR BID NO. TS12-S-13**

**PART 1AB : SUPPLY AND INSTALLATION OF SUBSTATION EQUIPMENT**

**SUPPLY AND CONSTRUCTION OF 230/115 KV CHON BURI 2 SUBSTATION (230 KV GIS), EXPANSION OF 230 KV BO WIN SUBSTATION, AND IMPROVEMENT OF 230 KV AO PHAI AND 230 KV PHAN THONG SUBSTATIONS**

**TRANSMISSION SYSTEM EXPANSION PROJECT NO. 12**

Description	Currency	Supply of Equipment		Local Transportation, Construction and Installation (excluding VAT) Baht
		Foreign Supply	Local Supply	
		CIF Thai Port	Ex-works Price (excluding VAT) Baht	
		Amount	Amount	
Schedule 1AB24 : Control and Protection System			22,409,730.00	2,240,973.00
Schedule 1AB25 : Fault Recording System			4,957,316.00	495,732.00
Schedule 1AB33 : CCTV			1,750,574.00	619,738.00
Schedule 1AB34 : 48 VDC Stationary Battery, Battery Charger and DC Power Panel			594,000.00	75,000.00

นางสาววัลลภา ชิวชนากรณ์กุล

ทจตส-ท.

15 พ.ค. 2562

- Project 1-1C6 -

(นางสาวพนา สุวภาค)  
 อว. 1812/๒๖๖

filename : TS12-S-13-1 (230,115 kV CB2)

**MEDIUM COST FOR BID NO. TS12-S-13**

**PART 1AB : SUPPLY AND INSTALLATION OF SUBSTATION EQUIPMENT**

**SUPPLY AND CONSTRUCTION OF 230/115 KV CHON BURI 2 SUBSTATION (230 KV GIS), EXPANSION OF 230 KV BO WIN SUBSTATION, AND IMPROVEMENT OF 230 KV AO PHAI AND 230 KV PHAN THONG SUBSTATIONS**

**TRANSMISSION SYSTEM EXPANSION PROJECT NO. 12**

Description	Currency	Supply of Equipment		Local Transportation, Construction and Installation (excluding VAT) Baht
		Foreign Supply	Local Supply	
		CIF Thai Port	Ex-works Price (excluding VAT) Baht	
		Amount	Amount	
Schedule 1AB35 : Optical Fiber and Line Accessories			293,980.00	483,160.00
Schedule 1AB38 : Remote Terminal Unit				983,540.00
Schedule 1AB39 : Commissioning				4,282,000.00
<b>PART 1AB</b>	<b>THB</b>	<b>300,999,363.19</b>	<b>Baht</b>	<b>Baht</b>
			<b>93,222,557.37</b>	<b>54,162,079.59</b>

นางสาววิมลภา ชื่นนากรณ์กุล  
 หจตส-ท.

15 พ.ค. 2562

- Project 1-1C7 -

นางสาววิมลภา ชื่นนากรณ์กุล  
 18/4/62

filename : TS12-S-13-1 (230,115 kV CB2)

## MEDIUM COST FOR BID NO. TS12-S-13

## PART 1C : CIVIL WORK

SUPPLY AND CONSTRUCTION OF 230/115 KV CHON BURI 2 SUBSTATION (230 KV GIS), EXPANSION OF 230 KV BO WIN SUBSTATION, AND IMPROVEMENT OF 230 KV AO PHAI AND 230 KV PHAN THONG SUBSTATIONS

## TRANSMISSION SYSTEM EXPANSION PROJECT NO. 12

Description	Local Currency (excluding VAT) Baht	
	Amount	
Schedule 1C1 : Foundation Work		9,013,931.00
Schedule 1C2 : Cable Trench		7,705,709.00
Schedule 1C3 : Control Building		99,914,694.00
Schedule 1C4 : Earth Work, Road and Crushed Rock Surfacing		7,147,142.00
Schedule 1C5 : Water Supply System		743,078.00
Schedule 1C6 : Drainage System		18,014,999.00
Schedule 1C7 : Special Construction Works		3,023,369.48
Schedule 1C8 : Miscellaneous		1,861,130.00
Schedule 1C9 : Fire Protection System		29,100,946.00
 PART 1C	<b>Baht</b>	<b>176,524,998.48</b>

นางสาววัลลภา ชีวนากรมกุล

ทจตส-ท.

15 พ.ค. 2562

Rev.24

- Project 1-1C1 -

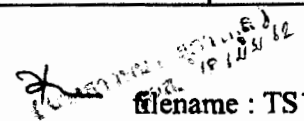
 filename : TS12-S-13-1 (230.115 kV CB2)



**MEDIUM COST FOR BID NO. TS12-S-13**  
**PART 1D : SUPPLY OF SPARE PARTS**  
**SUPPLY AND CONSTRUCTION OF 230/115 KV CHON BURI 2 SUBSTATION (230 KV GIS), EXPANSION OF 230 KV BO WIN SUBSTATION, AND**  
**IMPROVEMENT OF 230 KV AO PHAI AND 230 KV PHAN THONG SUBSTATIONS**  
**TRANSMISSION SYSTEM EXPANSION PROJECT NO. 12**

Description	Currency	Supply of Equipment		Local Transportation (excluding VAT) Baht
		Foreign Supply	Local Supply	
		CIF Thai Port	Ex-works Price (excluding VAT) Baht	
		Amount	Amount	
Schedule 1D7 : Spare Parts for SF6 Gas Insulated Switchgear	THB	4,456,694.00		222,834.70
Schedule 1D9 : Spare Parts for Power Circuit Breaker	THB	190,339.60		9,516.99
Schedule 1D11 : Spare Parts for Power Fuse, Fuse Link and Hook Stick	THB	54,931.80		2,746.62
Schedule 1D24 : Spare Parts for Control and Protection System			2,574,367.00	128,712.00
Schedule 1D25 : Spare Parts for Fault Recording System			420,523.00	21,021.00
<b>PART 1D</b>	<b>THB</b>	<b>4,701,965.40</b>	<b>Baht</b>	<b>Baht</b>
			<b>2,994,890.00</b>	<b>384,831.31</b>

นางสาววัลลภา ชื่นมากรณ์กุล

ทงตส-ท.

15 พ.ค. 2562

- Project 1-1C1 -

นางสาวพนา สุภาวดี  
 18 มิ.ย. 62  
 อวต filename : TS12-S-13-1 (230,115 kV CB2)

**MEDIUM COST FOR BID NO. TS12-S-13  
SCHEDULE 2 : 230 KV BO WIN SUBSTATION**

**SUPPLY AND CONSTRUCTION OF 230/115 KV CHON BURI 2 SUBSTATION (230 KV GIS), EXPANSION OF 230 KV BO WIN SUBSTATION, AND  
IMPROVEMENT OF 230 KV AO PHAI AND 230 KV PHAN THONG SUBSTATIONS**

**TRANSMISSION SYSTEM EXPANSION PROJECT NO. 12**

Description	Currency	Supply of Equipment		Local Currency (excluding VAT) Baht Amount	Local Transportation (excluding VAT) Baht Amount	Local Transportation, Construction and Installation (excluding VAT) Baht Amount
		Foreign Supply	Local Supply			
		CIF Thai Port	Ex-works Price (excluding VAT) Baht			
		Amount	Amount			
PART 2AB : SUPPLY AND INSTALLATION OF SUBSTATION EQUIPMENT	THB	12,288,494.14	32,418,462.63			10,200,361.46
PART 2C : CIVIL WORK				30,924,147.91		
PART 2D : SUPPLY OF SPARE PARTS	THB	287,762.20			14,388.12	
<b>TOTAL PRICE</b>	<b>THB</b>	<b>12,576,256.34</b>	<b>Baht</b> 32,418,462.63	<b>Baht</b> 30,924,147.91	<b>Baht</b> 14,388.12	<b>Baht</b> 10,200,361.46

## MEDIUM COST FOR BID NO. TS12-S-13

## PART 2AB : SUPPLY AND INSTALLATION OF SUBSTATION EQUIPMENT

## SUPPLY AND CONSTRUCTION OF 230/115 KV CHON BURI 2 SUBSTATION (230 KV GIS), EXPANSION OF 230 KV BO WIN SUBSTATION, AND IMPROVEMENT OF 230 KV AO PHAI AND 230 KV PHAN THONG SUBSTATIONS

## TRANSMISSION SYSTEM EXPANSION PROJECT NO. 12

Description	Currency	Supply of Equipment		Local Transportation, Construction and Installation ( excluding VAT ) Baht
		Foreign Supply	Local Supply	
		CIF Thai Port	Ex-works Price ( excluding VAT ) Baht	
		Amount	Amount	
Schedule 2AB5 : Current Transformer and Junction Box			245,000.00	900,130.00
Schedule 2AB6 : Coupling Capacitor Voltage Transformer, Coupling Capacitor, Voltage Transformer and Junction Box	THB	501,600.00	131,615.26	246,686.00
Schedule 2AB9 : Power Circuit Breaker	THB	4,161,300.00	137,065.50	1,112,927.15



นางสาววัลลภา ชีวนากรณ์กุล

หจตส-ท.

15 พ.ค. 2562

## MEDIUM COST FOR BID NO. TS12-S-13

## PART 2AB : SUPPLY AND INSTALLATION OF SUBSTATION EQUIPMENT

## SUPPLY AND CONSTRUCTION OF 230/115 KV CHON BURI 2 SUBSTATION (230 KV GIS), EXPANSION OF 230 KV BO WIN SUBSTATION, AND IMPROVEMENT OF 230 KV AO PHAI AND 230 KV PHAN THONG SUBSTATIONS

## TRANSMISSION SYSTEM EXPANSION PROJECT NO. 12

Description	Currency	Supply of Equipment		Local Transportation, Construction and Installation (excluding VAT) Baht
		Foreign Supply	Local Supply	
		CIF Thai Port	Ex-works Price (excluding VAT) Baht	
		Amount	Amount	
Schedule 2AB10 : Disconnecting Switch	THB	6,476,800.00	1,778,299.60	908,060.96
Schedule 2AB12 : AC&DC Distribution Board and Termination Box			1,056,993.00	116,269.23
Schedule 2AB14 : Substation Steel Structure			6,145,027.99	1,435,510.33
Schedule 2AB15 : Insulator				275,212.08

**MEDIUM COST FOR BID NO. TS12-S-13**

**PART 2AB : SUPPLY AND INSTALLATION OF SUBSTATION EQUIPMENT**

**SUPPLY AND CONSTRUCTION OF 230/115 KV CHON BURI 2 SUBSTATION (230 KV GIS), EXPANSION OF 230 KV BO WIN SUBSTATION, AND IMPROVEMENT OF 230 KV AO PHAI AND 230 KV PHAN THONG SUBSTATIONS**

**TRANSMISSION SYSTEM EXPANSION PROJECT NO. 12**

Description	Currency	Supply of Equipment		Local Transportation, Construction and Installation (excluding VAT) Baht
		Foreign Supply	Local Supply	
		CIF Thai Port	Ex-works Price (excluding VAT) Baht	
		Amount	Amount	
Schedule 2AB18 : Low Voltage Cable and Conductor			11,691,208.32	2,679,235.24
Schedule 2AB19 : Switchyard Lighting Fixtures			127,710.00	78,230.45
Schedule 2AB20 : Aluminum Tube, Connector and Miscellaneous Hardware			846,773.40	194,052.24
Schedule 2AB21 : Bus Fitting	THB	557,777.64		127,824.04

**MEDIUM COST FOR BID NO. TS12-S-13**

**PART 2AB : SUPPLY AND INSTALLATION OF SUBSTATION EQUIPMENT**

**SUPPLY AND CONSTRUCTION OF 230/115 KV CHON BURI 2 SUBSTATION (230 KV GIS), EXPANSION OF 230 KV BO WIN SUBSTATION, AND IMPROVEMENT OF 230 KV AO PHAI AND 230 KV PHAN THONG SUBSTATIONS**

**TRANSMISSION SYSTEM EXPANSION PROJECT NO. 12**

Description	Currency	Supply of Equipment		Local Transportation, Construction and Installation ( excluding VAT ) Baht Amount
		Foreign Supply	Local Supply	
		CIF Thai Port	Ex-works Price ( excluding VAT ) Baht	
		Amount	Amount	
Schedule 2AB22 : Grounding Material	THB	465,817.14	901,472.08	313,337.11
Schedule 2AB23 : Substation Miscellaneous	THB	125,199.36	471,984.48	136,854.63
Schedule 2AB24 : Control and Protection System			6,812,984.00	718,258.00
Schedule 2AB25 : Fault Recording System			1,972,669.00	215,761.00

นางสาววิไลลา ชิวชมกรณกุล

ทจตส-ท.

15 พ.ค. 2562

**MEDIUM COST FOR BID NO. TS12-S-13**

**PART 2AB : SUPPLY AND INSTALLATION OF SUBSTATION EQUIPMENT**

**SUPPLY AND CONSTRUCTION OF 230/115 KV CHON BURI 2 SUBSTATION (230 KV GIS), EXPANSION OF 230 KV BO WIN SUBSTATION, AND IMPROVEMENT OF 230 KV AO PHAI AND 230 KV PHAN THONG SUBSTATIONS**

**TRANSMISSION SYSTEM EXPANSION PROJECT NO. 12**

Description	Currency	Supply of Equipment		Local Transportation, Construction and Installation (excluding VAT) Baht
		Foreign Supply	Local Supply	
		CIF Thai Port	Ex-works Price (excluding VAT) Baht	
		Amount	Amount	
Schedule 2AB35 : Optical Fiber and Line Accessories			99,660.00	145,800.00
Schedule 2AB38 : Remote Terminal Unit				164,213.00
Schedule 2AB39 : Commissioning				432,000.00
<b>PART 2AB</b> นางสาววัลลภา ชีวนากรณ์กุล ทจตส-ท.	<b>THB</b>	<b>12,288,494.14</b>	<b>Baht 32,418,462.63</b>	<b>Baht 10,200,361.46</b>

**MEDIUM COST FOR BID NO. TS12-S-13**

**PART 2C : CIVIL WORK**

**SUPPLY AND CONSTRUCTION OF 230/115 KV CHON BURI 2 SUBSTATION (230 KV GIS), EXPANSION OF 230 KV BO WIN SUBSTATION, AND IMPROVEMENT OF 230 KV AO PHAI AND 230 KV PHAN THONG SUBSTATIONS**

**TRANSMISSION SYSTEM EXPANSION PROJECT NO. 12**

Description	Local Currency ( excluding VAT ) Baht
	Amount
Schedule 2C1 : Foundation Work	4,267,816.00
Schedule 2C2 : Cable Trench	2,508,584.50
Schedule 2C3 : Control Building	343,643.60
Schedule 2C4 : Earth Work, Road and Crushed Rock Surfacing	2,059,513.00
Schedule 2C5 : Water Supply System	9,500.00
Schedule 2C6 : Drainage System	3,278,401.50
Schedule 2C7 : Special Construction Works	903,787.31
Schedule 2C8 : Miscellaneous	289,896.00
Schedule 2C9 : Fire Protection System	17,263,006.00
<b>PART 2C</b>	<b>Baht 30,924,147.91</b>

นางสาววัลลภา ชื่นมากรณ์กุล  
ทจตส-ท.

นางสาววัลลภา ชื่นมากรณ์กุล  
18/10/62  
filename : TS12-S-13-2 (230 kV BWN)



**MEDIUM COST FOR BID NO. TS12-S-13**

**PART 2D : SUPPLY OF SPARE PARTS**

**SUPPLY AND CONSTRUCTION OF 230/115 KV CHON BURI 2 SUBSTATION (230 KV GIS), EXPANSION OF 230 KV BO WIN SUBSTATION, AND IMPROVEMENT OF 230 KV AO PHAI AND 230 KV PHAN THONG SUBSTATIONS**

**TRANSMISSION SYSTEM EXPANSION PROJECT NO. 12**

Description	Currency	Supply of Equipment		Local Transportation (excluding VAT) Baht Amount
		Foreign Supply	Local Supply	
		CIF Thai Port	Ex-works Price (excluding VAT) Baht	
		Amount	Amount	
Schedule 2D9 : Spare Parts for Power Circuit Breaker	THB	287,762.20		14,388.12
<b>PART 2D</b>	<b>THB</b>	<b>287,762.20</b>	<b>Baht</b>	<b>14,388.12</b>

นางสาววัลลภา ชิวชนากรณ์กุล  
ทจตส-ท.

(นางสาววัลลภา ชิวชนากรณ์กุล)  
18/11/62  
Filename : TS12-S-13-2 (230 kV BWN)

**MEDIUM COST FOR BID NO. TS12-S-13**  
**SCHEDULE 3 : 230 KV AO PHAI SUBSTATION**  
**SUPPLY AND CONSTRUCTION OF 230/115 KV CHON BURI 2 SUBSTATION (230 KV GIS), EXPANSION OF 230 KV BO WIN SUBSTATION, AND IMPROVEMENT OF 230 KV AO PHAI AND 230 KV PHAN THONG SUBSTATIONS TRANSMISSION SYSTEM EXPANSION PROJECT NO. 12**

Description	Currency	Supply of Equipment		Local Transportation, Construction and Installation (excluding VAT) Baht
		Foreign Supply	Local Supply	
		CIF Thai Port	Ex-works Price (excluding VAT) Baht	
		Amount	Amount	
PART 3AB : SUPPLY AND INSTALLATION OF SUBSTATION EQUIPMENT			658,858.00	563,950.00
<b>TOTAL PRICE</b>			<b>Baht 658,858.00</b>	<b>Baht 563,950.00</b>

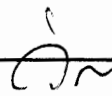

นางสาววัลลภา ชีวธนากรณกุล

ทจตส-ท.

15 พ.ค. 2562

- Project 1-3C1 -

นางสาวพนา สุภาวดี  
 18 มิ.ย. 62  
 filename : TS12-S-13-3 (230 kV AP)

**MEDIUM COST FOR BID NO. TS12-S-13**

**PART 3AB : SUPPLY AND INSTALLATION OF SUBSTATION EQUIPMENT**

**SUPPLY AND CONSTRUCTION OF 230/115 KV CHON BURI 2 SUBSTATION (230 KV GIS), EXPANSION OF 230 KV BO WIN SUBSTATION, AND IMPROVEMENT OF 230 KV AO PHAI AND 230 KV PHAN THONG SUBSTATIONS**

**TRANSMISSION SYSTEM EXPANSION PROJECT NO. 12**

Description	Currency	Supply of Equipment		Local Transportation, Construction and Installation (excluding VAT) Baht
		Foreign Supply	Local Supply	
		CIF Thai Port	Ex-works Price (excluding VAT) Baht	
		Amount	Amount	
Schedule 3AB24 : Control and Protection System			658,858.00	81,421.00
Schedule 3AB25 : Fault Recording System				49,191.00
Schedule 3AB38 : Remote Terminal Unit				1,338.00

*Or*

นางสาววิมลภา ชิวชนากรณ์กุล  
ทจตส-ท.

**MEDIUM COST FOR BID NO. TS12-S-13**

**PART 3AB : SUPPLY AND INSTALLATION OF SUBSTATION EQUIPMENT**

**SUPPLY AND CONSTRUCTION OF 230/115 KV CHON BURI 2 SUBSTATION (230 KV GIS), EXPANSION OF 230 KV BO WIN SUBSTATION, AND IMPROVEMENT OF 230 KV AO PHAI AND 230 KV PHAN THONG SUBSTATIONS**

**TRANSMISSION SYSTEM EXPANSION PROJECT NO. 12**

Description	Currency	Supply of Equipment		Local Transportation, Construction and Installation (excluding VAT) Baht
		Foreign Supply	Local Supply	
		CIF Thai Port	Ex-works Price (excluding VAT) Baht	
		Amount	Amount	
Schedule 3AB39 : Commissioning				432,000.00
<b>PART 3AB</b>			<b>Baht</b> <b>658,858.00</b>	<b>Baht</b> <b>563,950.00</b>

*Or*

นางสาววัลลภา ชีวนากรณ์กุล  
หจตส-ท.

15 พ.ค. 2562

นางสาวพนา สุวาทะ  
18 เม.ย. 62  
filename : TS12-S-13-3 (230 kV AP)

**MEDIUM COST FOR BID NO. TS12-S-13  
SCHEDULE 4 : 230 KV PHAN THONG SUBSTATION**

**SUPPLY AND CONSTRUCTION OF 230/115 KV CHON BURI 2 SUBSTATION (230 KV GIS), EXPANSION OF 230 KV  
BO WIN SUBSTATION, AND IMPROVEMENT OF 230 KV AO PHAI AND 230 KV PHAN THONG SUBSTATIONS  
TRANSMISSION SYSTEM EXPANSION PROJECT NO. 12**

Description	Currency	Supply of Equipment		Local Transportation, Construction and Installation (excluding VAT ) Baht Amount
		Foreign Supply	Local Supply	
		CIF Thai Port	Ex-works Price (excluding VAT ) Baht	
		Amount	Amount	
PART 4AB : SUPPLY AND INSTALLATION OF SUBSTATION EQUIPMENT			5,719,825.00	1,406,560.50
<b>TOTAL PRICE</b>			<b>Baht 5,719,825.00</b>	<b>Baht 1,406,560.50</b>

*Dr*

นางสาววัลลภา ชีวนากรณ์กุล

ทจตส-ท.

15 พ.ค. 2562

- Project 1-4C1 -

(นางสาววัลลภา ชีวนากรณ์กุล)  
8 พ.ค. 2562  
Filename : TS12-S-13-4 (230 kV PTG)

**MEDIUM COST FOR BID NO. TS12-S-13**

**PART 4AB : SUPPLY AND INSTALLATION OF SUBSTATION EQUIPMENT**

**SUPPLY AND CONSTRUCTION OF 230/115 KV CHON BURI 2 SUBSTATION (230 KV GIS), EXPANSION OF 230 KV BO WIN SUBSTATION, AND IMPROVEMENT OF 230 KV AO PHAI AND 230 KV PHAN THONG SUBSTATIONS**

**TRANSMISSION SYSTEM EXPANSION PROJECT NO. 12**

Description	Currency	Supply of Equipment		Local Transportation, Construction and Installation (excluding VAT) Baht
		Foreign Supply	Local Supply	
		CIF Thai Port	Ex-works Price (excluding VAT) Baht	
		Amount	Amount	
Schedule 4AB18 : Low Voltage Cable and Conductor			1,283,282.00	320,820.50
Schedule 4AB24 : Control and Protection System			2,463,874.00	272,584.00
Schedule 4AB25 : Fault Recording System			1,972,669.00	216,943.00
Schedule 4AB38 : Remote Terminal Unit				164,213.00

นางสาววัลลภา ชิวณากรณ์กุล  
 หจตส-ท.

15 พ.ค. 2562

- Project 1-4C1 -

นางสาวภา สุภานุกุล  
 18/10/62  
 filename : TS12-S-13-4 (230 kV PTG)

**MEDIUM COST FOR BID NO. TS12-S-13**

**PART 4AB : SUPPLY AND INSTALLATION OF SUBSTATION EQUIPMENT**

**SUPPLY AND CONSTRUCTION OF 230/115 KV CHON BURI 2 SUBSTATION (230 KV GIS), EXPANSION OF 230 KV BO WIN SUBSTATION, AND IMPROVEMENT OF 230 KV AO PHAI AND 230 KV PHAN THONG SUBSTATIONS**

**TRANSMISSION SYSTEM EXPANSION PROJECT NO. 12**

Description	Currency	Supply of Equipment		Local Transportation, Construction and Installation (excluding VAT) Baht
		Foreign Supply	Local Supply	
		CIF Thai Port	Ex-works Price (excluding VAT) Baht	
		Amount	Amount	
Schedule 4AB39 : Commissioning				432,000.00
<b>PART 4AB</b>			<b>Baht 5,719,825.00</b>	<b>Baht 1,406,560.50</b>

*Handwritten signature*

นางสาววัลลภา ชิวณากรณ์กุล  
ทจตส-ท.

*Handwritten signature*  
นางสาววัลลภา ชิวณากรณ์กุล  
18 เม.ย. 62  
Filename : TS12-S-13-4 (230 kV PTG)

**DATA SHEET**  
**for**  
**Invitation to Bid No. TS12-S-13**  
**(Two-envelope)**

---

This Section consists of provisions that are specific to each procurement and supplement the information or requirements included in Bidding Documents.

**Article B-3. Bid Security**

The amount of bid security shall be USD 1,227,820.- or THB 39,250,000.-.

**Article B-4. Validity of Bids**

The validity of the bid shall be for two hundred and seventy (270) Days from the date specified for opening of technical proposals.

**Article F-15. Liquidated Damages for Late Completion and Late Delivery,**  
**item a. For Complete Construction of Substation,**

If the Contractor fails to meet any of the completion dates for Schedule 1 : 230/115 kV Chon Buri 2 Substation (230 kV GIS) or Schedule 2 : 230 kV Bo Win Substation or Schedule 3 : 230 kV Ao Phai Substation or Schedule 4 : 230 kV Phan Thong Substation, the liquidated damages shall be at the rate of one-tenth of one (0.10) per cent of the total Contract Price for Schedule 1 : 230/115 kV Chon Buri 2 Substation (230 kV GIS) and Schedule 2 : 230 kV Bo Win Substation and Schedule 3 : 230 kV Ao Phai Substation and Schedule 4 : 230 kV Phan Thong Substation for each Day of delay. This sum is payable regardless of the actual loss and/or damages incurred. In no event shall the aggregate amount of liquidated damages exceed ten (10) per cent of the total Contract Price of those schedules.



**Maintenance Guarantee Period**

- For all Work except 500 kV System

The Contractor shall guarantee the proper functioning of the Work for a period of one (1) Year except the following Equipment the guarantee period of which shall be as follows :

<u>Equipment</u>	<u>Period of Guarantee (Year)</u>
- Fault Recording System	2
- Control and Protection System	2

- For 500 kV System

The Contractor shall guarantee the proper functioning of the Work for a period of five (5) Years.

**Defective Equipment to be replaced with the whole new set**

Not Applicable

# **ELECTRICITY GENERATING AUTHORITY OF THAILAND**

Nonthaburi  
Thailand

## **INVITATION TO BID NO. TS12-S-13**

### **SUPPLY AND CONSTRUCTION OF 230/115 kV CHON BURI 2 SUBSTATION (230 kV GIS), EXPANSION OF 230 kV BO WIN SUBSTATION, AND IMPROVEMENT OF 230 kV AO PHAI AND 230 kV PHAN THONG SUBSTATIONS**

#### **TRANSMISSION SYSTEM EXPANSION PROJECT NO.12**

---

#### **Invitation**

The Electricity Generating Authority of Thailand (EGAT) hereby invites sealed bids for supply and construction of 230/115 kV Chon Buri 2 Substation (230 kV GIS), Expansion of 230 kV Bo Win Substation, and Improvement of 230 kV Ao Phai and 230 kV Phan Thong Substations under Transmission System Expansion Project No.12 as described herein in accordance with terms, conditions and Specifications described in these Bidding Documents.

#### **Work Description**

The supply and construction of 230/115 kV Chon Buri 2 Substation (230 kV GIS), Expansion of 230 kV Bo Win Substation, and Improvement of 230 kV Ao Phai and 230 kV Phan Thong Substations will be on a supply and construction basis, the Contractor shall be responsible for complete supply, installation, construction and also engineering design work to the standard specified and best modern practice. The substations to be constructed and the scope of work under this Invitation are described in Section H. Scope of Work.

#### **Eligibility of Bidders: General Requirements**

I. All Bidders shall meet the following requirements; failure to so comply shall constitute sufficient ground for rejection.

- a. The Bidder shall be a partnership, firm or company, either alone or in joint venture or in consortium.
- b. The Bidder shall be well-established and maintain a permanent place of business.

- c. The Bidder shall not be, or supply the Equipment, from the country under the state of Civil War.
- d. The Bidder shall be a juristic person who manufactures or provides such material or services, as the case may be, and not be named in the List of Work Abandoners published by the Office of Prime Minister and/or in the Debarment List and/or in the List of Work Abandoners declared by EGAT.
- e. The Bidder shall not be a Jointly Interested Bidder with other Bidders as from the date of EGAT's issuance of the Invitation to Bid, or shall not be a person who undertakes any action as an "Obstruction of Fair Price Competition" as defined in Additional Regulation for this Invitation.
- f. The Bidder shall not either be EGAT's consultant or involving in EGAT's consultancy company under this Invitation, or have EGAT's personnel involved in his business as shareholder having voting right that can control his business, director, manager, officer, employee, agent or consultant except for the ones who are officially ordered by EGAT to act or participate therein.
- g. The Bidder shall not be the person who is privileged or protected not to be taken any legal proceeding under Thai Court; provided that such Bidder's government declares that such special privilege is waived.
- h. In case of a joint venture or consortium, the Bidder shall carry out all the work under such formation from the time of bidding until the fulfillment of the Contract.
- i. ***The Bidder shall be a purchaser of the bidding documents from EGAT. For a joint venture or consortium, only one (1) member of the joint venture or consortium is required to purchase the bidding documents.***

***In the case where the Bidder is not the purchaser of the bidding documents, the purchaser shall notify EGAT of the name of the Bidder in writing prior to the bid opening.***

II. All Bidders should preferably meet the following requirements; failure to so comply may constitute sufficient ground for rejection.

- a. The Bidder shall have adequate fund to meet financial obligations incidental to this Contract.
- b. The Bidder shall supply documentary evidence established in accordance with Article B-8. Information to be Submitted with Bid to demonstrate adequately that he is eligible to bid and is qualified to perform the Contract if his bid is accepted. Bidder should also demonstrate his capacity to perform the Work either with or without the use of subcontractor.

## **Eligibility of Bidders: Technical Requirements**

### **I. All Bidders shall meet the following requirements; failure to so comply shall constitute sufficient ground for rejection.**

- a. Being well-established and maintaining a permanent place of business.

If the Bidder is a new company formed by acquisition of or merger with other companies or business units before submitting the Bid, the experience records of any of such previous companies or business units that meet the requirements set forth herein are acceptable as the experience records of the Bidder.

If Bidder is a new company formed by acquisition of or merger with other companies or business units, the pending claim of any of such previous companies or business units shall be considered pending claim of the Bidder.

Reference records of either the parent or affiliated companies shall not be considered as the record of such Bidder.

- b. The Bidder shall have one of the following qualifications regarding experiences executing contract of supply and construction substation.

1) Having experience with EGAT in executing at least one (1) contract as contractor (not as subcontractor) for supply and construction of a complete 115 kV or above conventional or GIS substation, with its overall performance satisfactory to EGAT;

2) Having experience in executing at least one (1) contracts as contractor (not as subcontractor) for supply and construction of 220 kV or above conventional or GIS substation in an overseas country (not his own country).

Experience record of the Bidder or either member of the joint venture /consortium, including experience record derived from being a member of other joint venture or consortium in previous project(s) is acceptable. It is not allowed to combine the experience records of each member of the joint venture/consortium in order to meet the experience requirements.

- c. Further to b.1) mentioned above, having a record of experience within the last ten (10) years on the technical knowledge and practical experience on design, construction and installation of Equipment of a 115 kV or above complete conventional or GIS substation. Bidder shall also demonstrate his capacity to perform Work.

Further to b.2) mentioned above, having a record of experience within the last ten (10) years on the technical knowledge and practical experience on design, construction and installation of Equipment of a 220 kV or above complete conventional or GIS substation. Bidder shall also demonstrate his capacity to perform Work.

Experience record of the Bidder or either member of the joint venture /consortium, including experience record derived from being a member of other joint venture or consortium in previous project(s) is acceptable, provided that there is a letter from the project owner certifying that the Works as

described in c. above were performed by the Bidder or either member of the joint venture/ consortium of this project. It is not allowed to combine the experience records of each member of the joint venture/consortium in order to meet the experience requirements.

With respect to item b. and c. above, reference records of either the parent or affiliated companies of the Bidder or of either member of joint venture or consortium shall not be acceptable. If the Bidder has previously formed as the joint venture/consortium with other company and the experience record(s) of the joint venture/consortium meet(s) the requirement set forth herein, such experience record(s) of the joint venture/consortium is(are) also acceptable as the experience record(s) of the Bidder.

d. The Bidder shall propose Equipment manufactured by the qualified manufacturers who shall fulfill the following requirements :

1. Regularly manufacturing of Equipment of the type and similar ratings proposed.
2. Being well-established and maintaining a permanent place of business.
3. The manufacturer shall have the experience records that meet the requirements set forth herein.

Reference records of either parent or affiliated companies shall not be considered as the records of such manufacturer.

4. If the Manufacturer is a new company formed by acquisition of or merger with other companies or business units, and any of such previous companies or business units has the experience records that meet the requirements set forth herein, such experience records are acceptable as the experience records of the new company, provided that each item of the equipment to be supplied under this bid shall be manufactured from the same source of supply as indicated in each of such relevant supply records as described in Item I.d.5 to I.d.6 below. Otherwise, it shall not be acceptable and shall be sufficient grounds for rejection.

For the avoidance of doubt, it is not allowed to combine the experience records of the previous companies or business units in order to meet the experience requirements.

5. For 230/115 kV Ratings of Gas-Insulated Switchgear (GIS). These Equipment shall be manufactured by the qualified manufacturers who shall fulfill the following requirements :

5.1 Having one of the following qualifications:

- 5.1.1 Proposing the Equipment of the type and ratings which has already been accepted by EGAT.

OR

- 5.1.2 For 230 kV Gas-Insulated Switchgear (GIS):

Having a supply record of Equipment of the type proposed (*type of enclosure, interrupter of circuit breaker, rated filling gas pressure*) at the nominal system voltage of 220 kV or above, 3000 A or above, 50 kA or above, with successful operation/use of at least three (3) consecutive years in overseas country (not his own country) and at least three (3) substations of which total GIS bays shall not be less than twelve (12).

However, the Equipment of the type and short circuit current ratings proposed shall have a supply record of successful operation/use of at least three (3) consecutive years in overseas country (not his own country) and at least one (1) substation of which total GIS bays shall not be less than four (4).

In case that the supply record of Equipment of the type and ratings proposed fulfills the requirement, the manufacturer may propose a newly developed or modified type of such Equipment with successful operation/use of at least three (3) substations of which total GIS bays shall not be less than twelve (12) and having minimum one (1) year in overseas country (not his own country). The detailed information of the development or modification shall be submitted with his proposal. EGAT, however, reserves the right and will make its own judgment whether or not to consider or accept the proposed developed or modified type.

For 115 kV Gas-Insulated Switchgear (GIS):

Having a supply record of Equipment of the type proposed (*type of enclosure, interrupter of circuit breaker, rated filling gas pressure*) at the nominal system voltage of 110 kV or above, 2000 A or above, 40 kA or above, with successful operation/use of at least three (3) consecutive years in overseas country (not his own country) and at least three (3) substations of which total GIS bays shall not be less than twelve (12).

However, the Equipment of the type and short circuit current ratings proposed shall have a supply record of successful operation/use of at least three (3) consecutive years in overseas country (not his own country) and at least one (1) substation of which total GIS bays shall not be less than four (4).

In case that the supply record of Equipment of the type and ratings proposed fulfills the requirement, the manufacturer may propose a newly developed or modified type of such Equipment with successful operation/use of at least three (3) substations of which total GIS bays shall not be less than twelve (12) and having minimum one (1) year in overseas country (not his own country). The detailed information of the development or modification shall be submitted with his proposal. EGAT, however, reserves the right and will make its own judgment whether or not to consider or accept the proposed developed or modified type.

- 5.2 Having a past design test record of the Equipment as proposed, if specified in EGAT's specification. Such past design test record shall conform to the test specified in EGAT's specification.
6. For 230 kV Control and Protection System and below, having the following qualifications:
  - 6.1 Being local manufacturer.
  - 6.2 Having one of the following qualifications :
    - 6.2.1 Having at least three (3) consecutive years' supply record of successful operation/use in 220 kV or above Transmission System of at least three (3) units of each type of Protective Relay Panels of which the characteristics are similar to the ones specified herein to EGAT or other Electricity Authorities of Thailand
  - OR
  - 6.2.2 Having a letter of acceptance for manufacturing and/or fabrication of the specific Equipment issued by EGAT within the scope specified therein.

**II. All Bidders should preferably meet the following technical requirements; failure to so comply may constitute sufficient ground for rejection.**

- a. The Bidder shall have sufficient capacity to carry out the work.
- b. The Bidder shall have no just or proper claims pending against him with respect to breach in the performance of Contract on other similar works awarded by EGAT. In case the Bidder is a joint venture/consortium, either member of the joint venture/consortium shall have no just or proper claims pending against him with respect to breach in the performance of Contract on other similar works awarded by EGAT.
- c. The Bidder himself or his subcontractors, at the time of submitting this proposal, shall not carry excessive work nor be in a default position with respect to work with EGAT. Unsatisfactory past performance on Contract awarded by EGAT may be a sufficient reason of being disqualified.
- d. The Bidder shall propose Equipment from manufacturers who fulfill the requirements below. If there is any deficiency, EGAT reserves the right to require the Bidder to propose new manufacturer or new type/model of Equipment without any additional cost to EGAT.
  1. Regularly manufacturing of Equipment of the type and similar ratings proposed.
  2. Being well-established and maintaining a permanent place of business
  3. The manufacturer shall have the experience records that meet the requirements set forth herein.

Reference records of either parent or affiliated companies shall not be considered as the records of such manufacturer.

4. If the Manufacturer is a new company formed by acquisition of or merger with other companies or business units, and any of such previous companies or business units has the experience records that meet the requirements set forth herein, such experience records are acceptable as the experience records of the new company, provided that each item of the equipment to be supplied under this bid shall be manufactured from the same source of supply as indicated in each of such relevant supply records as described in Item II.d.5 thru II.d.16 below.

For the avoidance of doubt, it is not allowed to combine the experience records of the previous companies or business units in order to meet the experience requirements.

5. For 230/115 kV Ratings of Power Circuit Breaker shall be manufactured by the qualified manufacturers who shall fulfill the following requirements :

- 5.1 Having one of the following qualifications:

- 5.1.1 Proposing the Equipment of the type and ratings which has already been accepted by EGAT.

OR

- 5.1.2 For 230 kV Power Circuit Breaker:

Having a supply record of Equipment of the type proposed at nominal system voltage of 220 kV or above, 3000 A or above, 50 kA or above, with successful operation/use of at least three (3) consecutive years in an overseas country (not his own country) and at least three (3) three phase sets.

However, the Equipment of the type and short circuit current ratings proposed shall have a supply record of successful operation/use of at least three (3) consecutive years in overseas country (not his own country) and at least one (1) three phase set.

In case that the supply record of Equipment of the type and ratings proposed fulfilled the requirement, the manufacturer may propose a newly developed or modified type of such Equipment with successful operation/use of at least one (1) year in overseas country (not his own country) and at least three (3) three phase sets. The detailed information of the development or modification shall be submitted with his proposal. EGAT, however, reserves the right and will make its own judgment whether or not to consider or accept the proposed developed or modified type.

For 115 kV Power Circuit Breaker:



Having a supply record of Equipment of the type proposed at nominal system voltage of 110 kV or above, 2000 A or above, 40 kA or above, with successful operation/use of at least three (3) consecutive years in an overseas country (not his own country) and at least three (3) three phase sets.

However, the Equipment of the type and short circuit current ratings proposed shall have a supply record of successful operation/use of at least three (3) consecutive years in overseas country (not his own country) and at least one (1) three phase set.

In case that the supply record of Equipment of the type and ratings proposed fulfilled the requirement, the manufacturer may propose a newly developed or modified type of such Equipment with successful operation/use for at least one (1) year in overseas country (not his own country) and at least three (3) three phase sets. The detailed information of the development or modification shall be submitted with his proposal. EGAT, however, reserves the right and will make its own judgment whether or not to consider or accept the proposed developed or modified type.

5.2 Having a past design test record of the Equipment as proposed, if specified in EGAT's specification. Such past design test record shall conform to the test specified in EGAT's specification.

6. For 230/115 kV Ratings of following Equipment: Instrument Transformer, Surge Arrester and Disconnecting Switch. These Equipment shall be manufactured by the qualified manufacturers who shall fulfill the following requirements :

6.1 Having one of the following qualifications:

6.1.1 Proposing the Equipment of the type and ratings which has already been accepted by EGAT.

OR

6.1.2 Having a supply record of Equipment of the type and ratings proposed with successful operation/use of at least three (3) three-phase sets and having minimum three (3) consecutive years in an overseas country (not his own country).

In case that the supply record of Equipment of the type and ratings proposed fulfills the requirement, the manufacturer may propose a newly developed or modified type of such Equipment with successful operation/use of at least three (3) three-phase sets and having minimum one (1) year in overseas country (not his own country). The detailed information of the development or modification shall be submitted with his proposal. EGAT, however, reserves the right and will make its own judgment

whether or not to consider or accept the proposed developed or modified type.

Supply records of the higher rating Equipment shall not be considered if the Bidder does not propose such higher rating Equipment in his bid.

6.2 Having a past design test record of the Equipment as proposed, if specified in EGAT's specification. Such past design test record shall conform to the test specified in EGAT's specification.

7. For 33, 22 and 11 kV ratings of following Equipment : Metal-Clad SF<sub>6</sub> Gas Insulated Switchgear, Power Circuit Breaker, Instrument Transformer, Disconnecting Switch and Surge Arrester

Having one of the following qualifications :

7.1 Proposing the Equipment of the type and ratings which has already been accepted by EGAT.

OR

7.2 Having a supply record of Equipment of the type and ratings proposed with successful operation/use of at least three (3) consecutive years in an overseas country (not his own country) and at least three (3) three phase sets. The ratings and features of Equipment shall be the same or similar rating as EGAT specifies.

In case that the supply record of Equipment of the type and ratings proposed fulfilled the requirement, the manufacturer may propose a newly developed or modified type of such Equipment with successful operation/use of at least one (1) year in overseas country (not his own country) and at least three (3) three phase sets. The detailed information of the development or modification shall be submitted with his proposal. EGAT, however, reserves the right and will make its own judgment whether or not to consider or accept the proposed developed or modified type.

Supply records of the higher rating Equipment shall not be considered if the Bidder does not propose such higher rating Equipment in his bid.

8. For Distribution Transformer, Power Fuse, AC&DC Distribution Board and Lighting Relay Panel (LRP), Load Center Unit Substation (LCUS), Junction Box, Battery Charger, Substation Steel Structure, 33 kV and below Cable Terminations, 115 kV and below XLPE Power Cable, Power Cable, Control Cable and Switchboard Wire, Lighting Cable, Copper Ground Wire, Overhead Ground Wire, Aluminum Conductor, Optical Fiber Cable, Switchyard Lighting Fixtures, Aluminum Tube, Compression Connector and Miscellaneous Hardware, Bus Fittings, Ground Rod, Thermite Welding Material, Grounding Hardware, Conduit and Conduit Fittings

8.1 Being local manufacturer for the following Equipment :

Distribution Transformer, AC&DC Distribution Board and Lighting Relay Panel (LRP), Load Center Unit Substation (LCUS), Junction Box, Battery Charger, Substation Steel Structure, 115 kV and below XLPE Power Cable, Power Cable, Control Cable and Switchboard Wire, Lighting Cable, Copper Ground Wire, Overhead Ground Wire, Aluminum Conductor, Single mode optical fiber cable, Switchyard Lighting Fixtures, Aluminum Tube, Compression Connector and Miscellaneous Hardware, Thermite Welding Material and Conduit.

8.2 Having been granted a licence for producing standard product by Thai Industrial Standard Institute (TISI), Ministry of Industry for the following Equipment:

60 kV through 115 kV XLPE Power Cable, Lighting cable and Aluminum conductor.

8.3 Having one of the following qualifications :

8.3.1 Having supply record of Equipment of the type and similar ratings proposed with successful operation/use for at least one (1) year.

OR

8.3.2 Having a letter of acceptance for manufacturing and/or fabrication of the specific Equipment issued by EGAT within the scope specified therein (For the local manufacturer).

9. For Insulator

Having one of the following qualifications :

9.1 Having supply record with successful operation/use for at least three (3) consecutive years in overseas country (not his own country) and for following equipment :

9.1.1 Suspension Insulator, at least 10,000 units having the similar ANSI class as proposed.

9.1.2 Station Post Insulator, having the similar ANSI technical reference number as proposed.

OR

9.2 Having a letter of acceptance for manufacturing and/or fabrication of the specific Equipment issued by EGAT within the scope specified therein (For the local manufacturer).

10. For Stationary Battery

Having one of the following qualifications :

10.1 Having supply record of Equipment of the type and similar ratings proposed with successful operation/use in substations/switchyards of at least three (3) consecutive years and at least three (3) sets.

In case that the supply record of Equipment of the type and similar ratings proposed fulfilled the requirements, the manufacturer may propose a newly developed or modified type of such Equipment with successful operation/use of at least one (1) year. The detailed information of the development or modification shall be submitted with his proposal. EGAT, however, reserves the right and will make its own judgement whether or not to consider or accept the proposed developed or modified type.

OR

10.2 Having a letter of acceptance for manufacturing and/or fabrication of the specific Equipment issued by EGAT within the scope specified therein (For the local manufacturer).

11. For above 33kV through 230 kV Outdoor Type Cable Termination and Cable Termination for GIS.

Having one of the following qualifications :

11.1 Proposing the Equipment of the type and ratings which have ever been accepted by EGAT.

OR

11.2 Having a supply record of Equipment of the type and ratings proposed with successful operation/use for at least three (3) consecutive years in an overseas country (not his own country) and at least five (5) three phase sets. The ratings and features of Equipment shall be the same or similar rating as EGAT specifies.

In case that the supply record of Equipment of the type and ratings proposed fulfilled the requirement, the manufacturer may propose a newly developed or modified type of such Equipment with successful operation/use for at least one (1) year in overseas country (not his own country) and at least five (5) three phase sets. The detailed information of the development or modification shall be submitted with his proposal. EGAT, however, reserves the right and will make its own judgment whether or not to consider or accept the proposed developed or modified type.

Supply records of the higher rating Equipment shall not be accepted if the Bidder does not propose such higher rating Equipment in his bid.

12. For 230 kV XLPE Power Cable

Having one of the following qualifications :

12.1 Having a supply record of Equipment of the type and similar ratings proposed with successful operation/use for at least three (3) consecutive years in an overseas country (not his own country).

OR

- 12.2 Having a letter of acceptance for manufacturing and/or fabrication of the specific Equipment issued by EGAT within the scope specified therein (For the local manufacturer).
13. Proposing the protective relay from the manufacturers as listed in EGAT's Specifications and shall be in compliance with the details specified in EGAT's Specifications. Type/Model of the main protective relays proposed shall be as specified in EGAT ACCEPTED MAIN RELAY LIST NO.1 and NO.2 attached at the end of Section A. Invitation to Bid.
14. For Fault Recording System.
  - 14.1 Having one of the following qualifications :
    - 14.1.1 The cabinet and all equipment is completely wired by the manufacturer before shipping to Thailand.
  - OR
  - 14.1.2 The cabinet and the equipment are wired in Thailand by the manufacturer that has obtained special permission from EGAT for manufacturing and/or fabrication of the Control and Protection System within the scope specified in the Letter of Permission which is issued by EGAT (for the local manufacturer). The design and engineering shall be performed by the FRS's manufacturer. The assembly, factory test and commissioning shall be in accordance with the FRS's manufacturer standard and performed under the manufacturer's supervisor.
- 14.2 The Fault Recording System (FRS) proposed shall be in compliance with the details specified in EGAT's Specifications. Manufacturer/type/model of FRS proposed shall be as specified in EGAT ACCEPTED FAULT RECORDING SYSTEM LIST attached at the end of Section A. Invitation to Bid
15. Being local manufacturer for steel supporting structure of Instrument Transformer, Surge Arrester and Disconnecting Switch.
16. For Closed-circuit television (CCTV) system and equipment
  - 16.1 Proposed camera and Network Video Recorder (NVR) manufacturer shall have a representative or a branch office of manufacturer in Thailand for at least ten (10) years.
  - 16.2 Proposed brand of IP cameras shall have a supply record of IP cameras for at least five hundred (500) IP cameras per contract with successful operation/use for at least three (3) years in Thailand.
  - 16.3 The bidder or subcontractor shall have one of the following qualifications:
    - 16.3.1 Having experiences in installation and cabling of outdoor-type IP cameras for at least fifty (50) cameras per contract with successful operation/use for at least three (3) years in Thailand.

OR

16.3.2 Having experiences in optical fiber cabling in substation switchyards for at least five (5) substations per contract with successful operation/use for at least three (3) years in Thailand.

16.4 Being local manufacturer for the following Equipment: CCTV Rack cabinet, Monitoring desk, CCTV pole, 12-core ADSS optical fiber cable.

e. Proposing the manufacturer who has no just or proper claims pending against Equipment of the same type/model to be proposed under this bid.

In case the manufacturer is a new company formed by acquisition or merger with other companies or business units, the pending claim of any of such previous companies or business units shall be considered pending claim of the manufacturer.

f. Proposing reputable subcontractors, for the portion of the work to be subcontracted, having adequate technical knowledge, ability and capacity to perform such work and having at least three years experience in the performance of similar work and of equal magnitude to the work to be subcontracted. If any proposed subcontractor(s) is (are) not qualified in the opinion of EGAT, the Bidder is required to select other subcontractor(s) at his own cost to the satisfaction of EGAT.

\*\*\*\*\*

**EGAT ACCEPTED MAIN RELAY LIST No.1**

Scheme	Accepted Type/Model	Manufacturer	Acceptance for			Notes
			500kV	230kV	115&69kV	
Current Differential	RED670	ABB	YES	YES	YES	
	P543	GE	YES	YES	YES	The manufacturer's name "ALSTOM" is changed to "GE"
	L90	GE	YES	YES	YES	
	SEL-311L	SEL	YES	YES	YES	
	7SD52	Siemens	YES	YES	YES	
	P543	Schneider Electric	YES	YES	YES	
	EF-LD	INGETEAM	YES	YES	YES	
	PCS-931	NR Electric	YES	YES	YES	
Distance Protection	REL670	ABB	YES	YES	YES	
	P443	GE	YES	YES	YES	The manufacturer's name "ALSTOM" is changed to "GE"
	D30	GE		YES	YES	Only for three pole tripping and line protection that no need carrier scheme.
	D60	GE		YES	YES	
	ALPSDA1	GE	YES	YES	YES	
	SEL-311C	SEL			YES	Only for three pole tripping and line protection that no need carrier scheme.
	SEL-421	SEL	YES	YES	YES	For 21P, 85, 67N. The relay with auto-reclosing function can not be accepted.
	7SA522	Siemens	YES	YES	YES	
	7SA6 series	Siemens	YES	YES	YES	
	GRZ200	Toshiba		YES	YES	
	ZLV	ZIV		YES	YES	
	P443	Schneider Electric	YES	YES	YES	
	EF-ZT	INGETEAM	YES	YES	YES	
	PCS-902	NR Electric	YES	YES	YES	
Transformer Differential	RET670	ABB	YES	YES	YES	
	RET650	ABB	YES	YES	YES	3-restraints.
	P64x	GE	YES	YES	YES	The manufacturer's name "ALSTOM" is changed to "GE"

ได้ตรวจสอบแล้ว  
 ลงชื่อ *น.ส.ล.*  
 (นายเมธา ธิพาน)  
 ทบ.-ส. 3/7/62  
 วันที่.....  
 กองวิศวกรรมระบบควบคุมและป้องกัน

**EGAT ACCEPTED MAIN RELAY LIST No.1**

Scheme	Accepted Type/Model	Manufacturer	Acceptance for			Notes
			500kV	230kV	115&69kV	
Transformer Differential	T35	GE		YES	YES	
	T60	GE		YES	YES	
	Duobias	Siemens		YES	YES	The manufacturer's name "Reyrolle" is changed to "Siemens"
	SEL-387	SEL		YES	YES	4-restraints.
	SEL-487E	SEL	YES	YES	YES	
	SEL-587	SEL			YES	2-restraints.
	SEL-787	SEL			YES	2-restraints.
	7UT6	Siemens	YES	YES	YES	5-restraints.
	GRT200	Toshiba	YES	YES	YES	
	IDV	ZIV	YES	YES	YES	
	P645	Schneider Electric	YES	YES	YES	
	EF-TD	INGETEAM	YES	YES	YES	3-restraints.
PCS-978	NR Electric	YES	YES	YES		
Busbar Protection High Impedance	REB650	ABB	YES	YES	YES	<div style="border: 1px solid blue; padding: 5px;"> <p align="center">ได้ตรวจสอบแล้ว</p> <p>ลงชื่อ.....</p> <p align="center">(นายเมธา ธิกุลาน)</p> <p>วันที่.....</p> <p align="center">ทวบ-ช. 31/7/62</p> <p align="center">กองวิศวกรรมระบบควบคุมและป้องกัน</p> </div>
	SEL-587Z	SEL	YES	YES	YES	
	GRB150	Toshiba	YES	YES	YES	
Busbar Protection Low Impedance	REB670	ABB	YES	YES	YES	
	REB500	ABB	YES	YES	YES	
	P746	GE	YES	YES	YES	The manufacturer's name "ALSTOM" is changed to "GE"
	P740	GE	YES	YES	YES	The manufacturer's name "ALSTOM" is changed to "GE"
	B90	GE	YES	YES	YES	
	B30	GE	YES	YES	YES	Only use in case that the bus arrangement is Breaker-and-a half, Double-bus-Double-Breaker or Main-and-Transfer.
	P747	GE	YES	YES	YES	
	SEL-487B	SEL	YES	YES	YES	
7SS52	Siemens	YES	YES	YES		



**EGAT ACCEPTED MAIN RELAY LIST No.1**

Scheme	Accepted Type/Model	Manufacturer	Acceptance for			Notes
			500kV	230kV	115&69kV	
Busbar Protection Low Impedance	7SS60	Siemens	YES	YES	YES	Only use in case that the bus arrangement is Breaker-and-a-half, Double-bus-Double-Breaker or Main-and-Transfer.
	7SS85	Siemens	YES	YES	YES	
	GRB100	Toshiba	YES	YES	YES	
	P746	Schneider Electric	YES	YES	YES	
	P740	Schneider Electric	YES	YES	YES	
Breaker Failure Protection	REQ650	ABB			YES	
	P141	GE	YES	YES	YES	3-phase Breaker failure function only. The manufacturer's name "ALSTOM" is changed to "GE"
	P14Nx	GE	YES	YES	YES	The manufacturer's name "ALSTOM" is changed to "GE"
	C60	GE		YES	YES	
	F60	GE		YES	YES	
	SEL-501	SEL	YES	YES	YES	3-phase Breaker failure function only.
	P821	Schneider Electric		YES	YES	Only firmware version 1.F is accepted.
	7VK6 series	Siemens	YES	YES	YES	The function and the operating time for each system shall be conform to Specification nos. 1005 and 1002.
	GRD200	Toshiba	YES	YES	YES	
	EF-ZT	INGETEAM	YES	YES	YES	
	PCS-9611	NR Electric	YES	YES	YES	3-phase Breaker failure function only.

**Note**

- The procedures for being listed in EGAT ACCEPTED MAIN RELAY LIST can be requested from Transmission System Engineering Division.
- If any type of relay in the list is planned not to be manufactured, the manufacturer or the representative is responsible for informing EGAT at least 1 year before it is obsolete.
- The relays shall be configured to comply with all EGAT's needed functions.

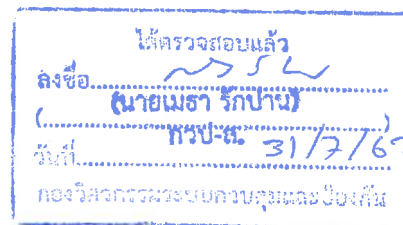

**EGAT ACCEPTED MAIN RELAY LIST No.2**

Scheme	Accepted Type/Model	Manufacturer	Acceptance for				Notes
			500kV	230kV	69&115kV	22&33kV	
Directional Overcurrent Relay	REQ650	ABB	YES	YES	YES	YES	
	P14Dx	GE	YES	YES	YES	YES	The manufacturer's name "ALSTOM" is changed to "GE"
	P841	GE	YES	YES	YES	YES	The manufacturer's name "ALSTOM" is changed to "GE"
	SEL-351A	SEL	YES	YES	YES	YES	
	SEL-451	SEL	YES	YES	YES	YES	
	SEL-751	SEL	YES	YES	YES	YES	
	GRE140	Toshiba	YES	YES	YES	YES	
	GRD200	Toshiba	YES	YES	YES	YES	
	7SJ62	Siemens	YES	YES	YES	YES	
	7SJ85	Siemens	YES	YES	YES	YES	
	IRV	ZIV		YES	YES	YES	
	EF-MD	INGETEAM	YES	YES	YES	YES	
	PCS-9611	NR Electric				YES	None of line fault locator. Only use with feeder.
Overcurrent Relay	REQ650	ABB	YES	YES	YES	YES	
	P141	GE	YES	YES	YES	YES	The manufacturer's name "ALSTOM" is changed to "GE"
	P14Dx	GE	YES	YES	YES	YES	The manufacturer's name "ALSTOM" is changed to "GE"
	P14Nx	GE	YES	YES	YES	YES	The manufacturer's name "ALSTOM" is changed to "GE"
	P841	GE	YES	YES	YES	YES	The manufacturer's name "ALSTOM" is changed to "GE"
	F60	GE	YES	YES	YES	YES	
	F650	GE	YES	YES	YES	YES	
	SR350	GE	YES	YES	YES	YES	
	P120	Schneider Electric	YES	YES	YES	YES	

ได้ตรวจสอบแล้ว  
 ลงชื่อ..... *mse*  
 (นายมนตรี รัตนาน)  
 วันที่..... กว.ศ. 31/2/62  
 กองวิศวกรรมระบบควบคุมและป้องกัน

*mse*

**EGAT ACCEPTED MAIN RELAY LIST No.2**

Scheme	Accepted Type/Model	Manufacturer	Acceptance for				Notes
			500kV	230kV	69&115kV	22&33kV	
Overcurrent Relay	P122	Schneider Electric	YES	YES	YES	YES	
	SEL-351A	SEL	YES	YES	YES	YES	
	SEL-451	SEL	YES	YES	YES	YES	
	SEL-551	SEL	YES	YES	YES	YES	
	SEL-751	SEL	YES	YES	YES	YES	
	SEL-751A	SEL	YES	YES	YES	YES	
	7SJ61	Siemens	YES	YES	YES	YES	
	7SJ62	Siemens	YES	YES	YES	YES	
	7SJ85	Siemens	YES	YES	YES	YES	
	GRE140	Toshiba	YES	YES	YES	YES	
	GRD200	Toshiba	YES	YES	YES	YES	
	IRV	ZIV		YES	YES	YES	
	EF-MD	INGETEAM	YES	YES	YES	YES	
	PCS-9611	NR Electric	YES	YES	YES	YES	3 pole trip only
Synchronism Check Relay	REQ650	ABB	YES	YES	YES		
	SPAU140C	ABB	YES	YES	YES		
	P841	GE	YES	YES	YES		The manufacturer's name "ALSTOM" is changed to "GE"
	F60	GE	YES	YES	YES		
	F650	GE	YES	YES	YES		
	SEL-279H	SEL	YES	YES	YES		
	SEL-351A	SEL	YES	YES	YES		
	SEL-451	SEL	YES	YES	YES		
	SEL-751	SEL	YES	YES	YES		
	SEL-751A	SEL	YES	YES	YES		
	7VK61	Siemens	YES	YES	YES		
	7SJ85	Siemens	YES	YES	YES		
	GRD200	Toshiba	YES	YES	YES		

ได้ตรวจสอบแล้ว  
 ลงชื่อ.....  
 (.....)  
 วันที่.....  
 กองวิศวกรรมระบบควบคุมและป้องกัน

**EGAT ACCEPTED MAIN RELAY LIST No.2**

Scheme	Accepted Type/Model	Manufacturer	Acceptance for				Notes
			500kV	230kV	69&115kV	22&33kV	
Synchronism Check Relay	EF-MD	INGETEAM	YES	YES	YES		
	PCS-9611	NR Electric	YES	YES	YES		
Auto Reclosing Relay	REQ650	ABB	YES	YES	YES		
	P841	GE	YES	YES	YES		The manufacturer's name "ALSTOM" is changed to "GE"
	F60	GE		YES	YES		3 pole reclose only
	F650	GE		YES	YES		3 pole reclose only
	DRS	GE		YES	YES		3 pole reclose only
	SEL-279H	SEL		YES	YES		3 pole reclose only
	SEL-351A	SEL		YES	YES		3 pole reclose only
	SEL-451	SEL		YES	YES		3 pole reclose only
	SEL-751	SEL		YES	YES		3 pole reclose only
	7VK512	Siemens	YES	YES	YES		
	7VK61	Siemens	YES	YES	YES		
	GRD200	Toshiba	YES	YES	YES		
	EF-ZT	INGETEAM	YES	YES	YES		
	PCS-9611	NR Electric		YES	YES		3 pole reclose only
Overfluxing Relay	EF-TD	INGETEAM	YES	YES	YES		
Frequency Relay	P94Vx	GE	YES	YES	YES	YES	The manufacturer's name "ALSTOM" is changed to "GE"
	MIV	GE		YES	YES	YES	
	SEL-351A	SEL	YES	YES	YES	YES	
	SEL-451	SEL	YES	YES	YES	YES	
	SEL-751	SEL	YES	YES	YES	YES	
	SEL-751A	SEL	YES	YES	YES	YES	
	7SJ85	Siemens	YES	YES	YES	YES	
	EF-MD	INGETEAM	YES	YES	YES	YES	
	PCS-9611	NR Electric	YES	YES	YES	YES	

ได้ตรวจสอบแล้ว  
 ลงชื่อ.....  
 (นายเมธา รัชพาน)  
 กวป.ส.  
 วันที่..... 31/7/19  
 กองวิศวกรรมระบบควบคุมและป้องกัน

**EGAT ACCEPTED MAIN RELAY LIST No.2**

Scheme	Accepted Type/Model	Manufacturer	Acceptance for				Notes
			500kV	230kV	69&115kV	22&33kV	
Under/Overvoltage Relay	MIV	GE		YES	YES	YES	
	P94V	GE	YES	YES	YES	YES	None of VT input (open delta connection) for 59N.
	SEL-351A	SEL	YES	YES	YES	YES	
	SEL-751	SEL	YES	YES	YES	YES	
	SEL-751A	SEL	YES	YES	YES	YES	
	7SJ62	Siemens	YES	YES	YES	YES	
	7SJ85	Siemens	YES	YES	YES	YES	
	GRD200	Toshiba	YES	YES	YES	YES	
	IRV	ZIV	YES	YES	YES	YES	
	EF-MD	INGETEAM	YES	YES	YES	YES	
	PCS-9611	NR Electric		YES	YES	YES	C-Bank protection only

**Note**

- The procedures for being listed in EGAT ACCEPTED MAIN RELAY LIST can be requested from Transmission System Engineering Division.
- If any type of relay in the list is planned not to be manufactured, the manufacturer or the representative is responsible for informing EGAT at least 1 year before
- The relays shall be configured to comply with all EGAT's needed functions.

ได้ตรวจสอบแล้ว  
 ลงชื่อ.....  
 (นายเมธา ธิกุลาน)  
 วันที่..... กวป-ส. 31/7/67  
 กองวิศวกรรมระบบควบคุมและป้องกัน

## EGAT ACCEPTED FAULT RECORDING SYSTEM LIST

Accepted Type/Model	Manufacturer
IDM+	QUALITROL
M871	GE
7KE85	SIEMENS
TESLA 4000	ERL Phase
TR2100	Rochester (RIS)

### Note

- The procedures for being listed in EGAT ACCEPTED FAULT RECORDING SYSTEM LIST can be obtained from Transmission System Engineering Division.
- If any type of FRS in the list is planned not to be manufactured, the manufacturer or the representative is responsible for informing EGAT at least 1 year before it is obsolete.



**EGAT ACCEPTED MANUFACTURER LIST FOR PROTECTIVE RELAY**

<b>Description</b>	<b>Manufacturer / Country</b>
Protective Relay	ABB / Sweden, Switzerland, USA
	GE / USA, Canada, Spain, UK
	SEL / USA
	Siemens / Germany
	Reyrolle / UK
	Toshiba / Japan, Vietnam
	Schneider Electric / France, UK
	ZIV / Spain
	INGETEAM / Spain
	NR Electric / China
	Mitsubishi / Japan



**EGAT ACCEPTED MANUFACTURER LIST FOR FAULT RECORDING SYSTEM**

<b>Description</b>	<b>Manufacturer / Country</b>
Fault Recording System	Qualitrol / UK
	Siemens / Germany
	Rochester / USA
	GE / USA
	ERL Phase / Canada





**SECTION H**  
**SCOPE OF WORK**

183

## SCOPE OF WORK

### **H-1. General**

<u>No.</u>	<u>Substation</u>	<u>Page</u>
1.	230/115 KV CHON BURI 2 SUBSTATION (CB2) (Job No. TS12-11-S11)	H1-1
2.	230 KV BO WIN SUBSTATION (BWN) (Job No. TS12-11-S12)	H2-1
3.	230 KV AO PHAI SUBSTATION (AP) (Job No. TS12-11-S18)	H3-1
4.	230 KV PHAN THONG SUBSTATION (PTG) (Job No. TS12-11-S19)	H4-1

## **1. 230/115KV CHON BURI 2 SUBSTATION (CB2) (Job No. TS12-11-S11)**

### **General**

The Transmission System Development for reinforcement to supply power demand of these areas is then needed. To enhance the transmission system's capability and to maintain its reliability, the construction of the new 230 kV Gas Insulated Substation (GIS) are required.

The new 230/115 kV Substation consists of 230 kV Gas Insulated Switchgear (GIS) with Breaker & A Half Scheme and 115 kV conventional switchyard. The GIS modules shall be installed inside the new separately GIS building.

The Contractor shall furnish a complete supply of equipment, materials and installation work etc., which is necessary to complete construction substation on a supply and construction basis, in accordance with the Contract Documents.

### **Schedule 1**

The 230/115kV Chon Buri 2 Substation is located at Tumbon Bang Phra, Amphur Si Racha, Chon Buri Province.

#### **230 kV Substation**

The new 230 kV Substation shall consist of 230kV indoor GIS and the bus arrangement shall be Breaker-and-a-half Scheme which consists of Ten (10) feeders as follows:

- Four (4) feeders for 300 MVA, 230/115-22 kV autotransformers  
KT1A, KT2A, KT3A, (KT4A For Future)
- Two (2) feeders for 230kV lines No.1 & No.2 to Phan Thong
- Two (2) feeders for 230kV lines No.1 & No.2 to Ao Phai
- Two (2) feeders for 230kV lines No.1 & No.2 to Bo Win

#### **115 kV Substation**

The new 115 kV conventional switchyard consists of three (3) feeders as follows:

- Three (3) Feeders for Line No.1 No.2 & No.3 PEA

The Contractor shall supply equipment, perform construction and installation work necessary for completion of operation substation in accordance with the Contract Documents. The design work shall include, but not limited to, technical calculation, preparation of drawings, bill of materials for installation and construction work. For accomplishment of complete operational substation, Scope of Contractor's work shall include connection to all public utilities i.e. electrical power, water and drainage. Testing and commissioning of all equipment required to make the substation function properly.

Besides, all detailed engineering design work, calculations, drawing preparation, submission of backup data, test reports instruction books (and), etc. shall be included.

1) As stated elsewhere in this bidding documents, the drawings included in the bidding documents except drawing mark "For Construction" are for bidding purposes only and shall not be used for execution of the work.

2) The submitted drawings which are incomplete/unacceptable, or are the bidding document copies with minor modifications shall be returned unmarked to the Contractor.

3) The drawings shall be furnished which provide all details required for thoroughly described equipment as well as installation methods and requirements. However, EGAT retains the right to request additional details if those furnished are perceived inadequate.

4) Calculations, backup data and documentation are required for all parts of the design. The furnished data shall verify completely that design is adequate for application purpose.

**Work included in this Contract.** The Work included in this Contract to be performed by the Contractor shall be as specified in the Contract Documents and as follows:

**For Electrical Work**

**1. 230 kV Gas Insulated switchgear (GIS) and 115 kV Conventional Substation**

- 1.1 Design, supply, and installation of equipment required for a complete 230 kV GIS Substation.
- 1.2 Design, supply, and installation of equipment required for a complete 115 kV Conventional Substation.
- 1.3 Design, supply, and installation of equipment required for a complete 22 kV power supply system.
- 1.4 Design, supply, and installation of miscellaneous hardware which comprises at least the following equipment:
  - 1.4.1 The connection from the 230kV GIS air bushings to
    - 230/115-22 kV autotransformers (KT1A, KT2A, KT3A)
    - 230 kV overhead lines
  - 1.4.2 The connection from 230 kV Substation (KT1A, KT2A, KT3A) to 115 kV Substation
  - 1.4.3 The connection equipment required for a complete 115 kV AIS and 22 kV system.
    - 115 kV overhead lines
- 1.5 To meet EGAT's service continuity requirements, the GIS gas compartment can be designed as indicated in the single line diagram or can be designed

differently under a condition that the design of the gas compartment shall fulfill the requirements as specified in the Specification.

- 1.6 Supply and installation of the marking pins for the referenced positions from the main bus shall be provided in the GIS building. The positions of the marking pins shall be shown on the drawings for future GIS extension and the quantity shall be not less than 3 sets. The making pins shall be made of brass or stainless steel that have the formation as follows:

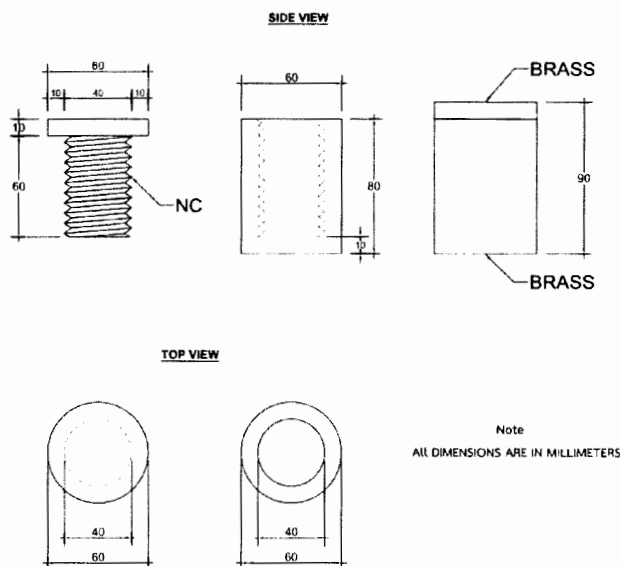

- 1.7 The GIB shall not be installed in multiple stacks for the purpose of convenient maintenance.
- 1.8 The detachable walk way (Cat walk) for visual inspection shall be properly installed on each GIS module and removable service platform, removable ladder shall be provided for GIS inspection.
- 1.9 The feeder nameplates as well as phasing and switching numbers shown on the GIS module shall be painted or mounted (detachable) type on the enclosure of GIS.
- 1.10 The sag and tension of phase wires and overhead ground wires shall be calculated and designed according to internationally-accepted standards by the Contractor and the said calculation shall be submitted to EGAT for approval.

## 2. Station service system

- 2.1 Design, supply, and installation of the station service system complete with integral accessories to provide the complete system operation. The station service system shall mainly consist of as follows:
- 250 kVA, 22,000-400/230 V distribution transformer (KW1A)
  - 250 kVA, 22,000-400/230 V distribution transformer (KW2A)
  - Load Center Unit Substation (LCUS)
  - 22 kV drop-out fuses
  - 600 V, 400 A safety switches

- 22 kV equipment, and AC&DC distribution boards, stationary batteries, battery chargers, power cables, and all related equipment for the complete operation.
- 2.2 The Load Center Unit Substation (LCUS) shall conform to 250 kVA, 22,000-400/230 V distribution transformers (KW1A & KW2A).
  - 2.3 Design, supply, and installation of equipment required for a complete 400/230 V power supply system.
  - 2.4 Design, supply, and installation of the stationary battery, in which the battery is capable of delivering power to the control and protection for tripping all circuit breakers and emergency essential load for at least 8 hours if normal station service fails. The capacity of the battery shall not be less than 600Ah. In case of bus faults occurring on the last hour of battery power, the battery shall generate sufficient power for tripping all circuit breakers. The stationary battery shall be designed and calculated in accordance with IEEE or other acceptable international standards. In addition, the size of the stationary battery shall be designed to support the operation of existing and future bay as shown on the attached bidding document drawings. The calculation shall be submitted to EGAT for approval.
  - 2.5 Design, supply and installation of emergency lighting system for the GIS building in case of normal station service fails with the illuminance of 150 LUX for at least 3 hours as shown in figure below.

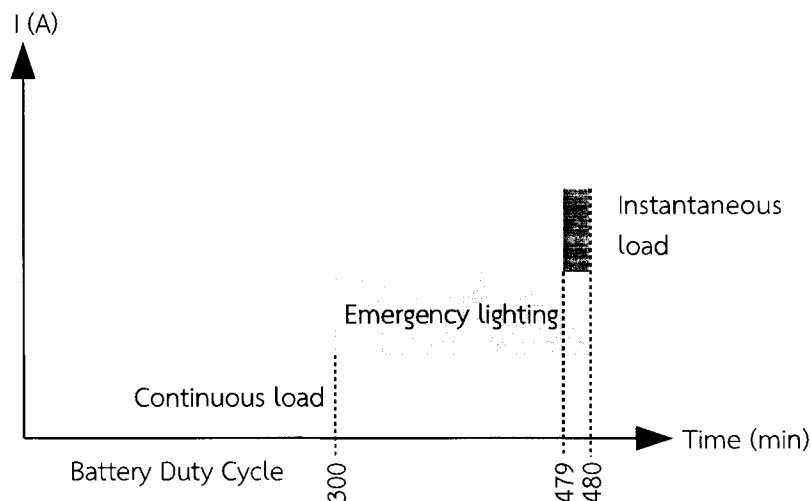

### 3. Grounding system

- 3.1 Design, supply, and installation of the grounding system of the following:
  - 230 kV GIS substations and 115 kV Conventional Substation.
  - 230 kV GIS building
  - Control building

The grounding conductor for the substation grounding system shall be of the 4/0 AWG bare copper wire type.

188

- 3.2 Design, supply, and installation of the grounding equipment and miscellaneous hardware for the 230 kV and 115 kV GIS substations and the 22 kV system.
- 3.3 The ground grid conductors spacing under the building area shall be the same as the Switchyard.
- 3.4 Design, supply, and installation of the grounding system of the isolating transformer. The grounding system of the isolating transformer shall be separated from that of the substation.
- 3.5 The contractor shall evaluate the price of ground grid based on the specified design for price reference as below:
  - 3.5.1 The maximum ground grid conductor spacing ( $D_0$ ) shall be 5 meters.
  - 3.5.2 The number of ground rod shall be 100 pieces.
- 3.6 The Contractor shall conduct the soil resistivity measurement. The result shall submitted to EGAT for approval.
- 3.7 The Contractor shall design a grounding grid based on the measured soil resistivity by hand calculation using the equations in IEEE-80 standard and submitted to EGAT for Approval. The parameters for grounding system calculation shall be used as follows;
  - Fault current division factor ( $s_f$ ) value = 1
  - Fault current (rms) = 50 kA
  - Time duration of fault = 1 second
  - The grounding conductor spacing for the grounding grid shall be 5.00m ( $D_0$ ).
  - The total number of ground rods shall be 100 pieces

These parameters shall be used for determine the size of grounding conductor for the substation grounding system. If the ground conductor spacing calculated by hand ( $D_1$ ) is less than the grounding conductor spacing for reference ( $D_0$ ), the Contractor shall design a grounding grid by using the software. The certification of software shall be acceptable for commercial use.

#### **4. Lightning protection**

- 4.1 Design, supply, and installation of the substation lightning protection system complete with all related equipment. The Contractor shall design the lightning protection system for the protection of all substation equipment which is under the protective zone. To meet EGAT's design criteria for the lightning protection system and to enhance the stability of lightning protection system, the Basic Insulation Level voltage (BIL) is to be used in calculation instead of Critical Flashover voltage (CFO) as follows:
  - 900 kV for 230 kV Substation
  - 550 kV for 115 kV Substation

For 22 kV Substation, the stroke current of 2 kA shall be used for the calculation.
- 4.2 For the design of lightning protection system for the GIS building the lightning protection level (LPL) shall be used level 1 for calculation and the overhead

ground wire is not permitted. Air terminal rods installed at the roof shall be used instead.

- 4.3 Lightning protection system shall be designed to meet IEC, NEMA and E.I.T. standards or internationally-accepted standards.

## **5. Facility system**

### **5.1. Outdoor facility system:**

5.1.1 Design, supply and installation of a switchyard lighting system complete with all integral accessories to provide a complete system operation. The lighting system shall mainly consist of equipment lighting, fence lighting, access road lighting, power box (PRB), sign board lighting relay panels, raceways, and wiring cables for lighting circuits.

5.1.2 The lamps for outdoor facility lighting system shall be LED type with all integral accessories, e.g. lamp holders, fixtures, reflectors, and etc. The Contractor shall provide drawings that show details for installation.

5.1.3 Design, supply, and installation of circuits for the main entrance gate. The control of the entrance gate shall be operated both manually and remote control which shall be controlled from the control room or the guardhouse.

### **5.2. Indoor facility system**

5.2.1 Design, supply, and installation of the facility system which mainly consists of lighting system, grounding system, power supply, fire alarm and protection system, and ventilation system, air-conditioning system, and telephone & LAN system in the control building and 230kV GIS building. All cable wiring systems shall conform to NEC and IEC standards or internationally-accepted standards.

5.2.2 The lamps for indoor facility lighting system shall be LED type with all integral accessories, e.g. lamp holders, fixtures, reflectors, and etc. The Contractor shall provide drawings that show details for installation and Specify the LED lamp and LED luminaire circuit identified that the LED lamp circuit shall be supplied by 2-3 manufacturers.

5.2.3 All steel accessories e.g. lip-channel, conduit, conduit fittings, conduit accessories, box and cover shall be hot dip galvanized.

5.2.4 The fire protection system of the indoor facility system shall mainly consist of a fire alarm control panel, smoke detector, heat detector, annunciator, fire exit-sign, and related accessories to the complete operation. The fire protection system shall be designed to meet NFPA or other acceptable international standards.

- 5.3 The size of low voltage cable shall be sufficient to keep the voltage drop at the load point less than 5% at rated load current.



- 5.4 The voltage drop from the safety switch to the AC boards and from the AC boards to the load shall not exceed 2% and 3 % respectively.

#### **6. Telecommunication system**

- 6.1 Design, supply, and installation of the 6.00 m. self support telecommunication tower installed on the roof of the 230 kV Control building. The telecommunication tower shall be constructed and divided into appropriate portions which are painted white and orange alternately with the top and bottom portions being painted orange. The obstruction lighting system shall be controlled by automatic flash box (AFB) that gives 30-60 flashes per minute. The AFB shall be turned on and turned off by a photo-light switch. The lightning protection system for the telecommunication tower shall be calculated and designed by the Contractor and the said calculation shall be submitted to EGAT for approval.

#### **7. Testing and commissioning**

- 7.1 Testing and commissioning of all equipment required to make the substation function properly.

#### **8. Other work**

- 8.1 Supply and installation of cable wiring from the marshalling control cubicle (MC002) to the associated equipment. (KT1A,KT2A,KT3A)
- 8.2 Modification of 22 kV bus supporting structure (BS203)
- 8.3 Modification of JB003 for installation of outdoor receptacle box
- 8.4 Modification of distribution transformers structure (DTS) for installation of station service transformers.

#### **Control and Protection System**

9. Design, supply, installation, wiring, test and commissioning of the complete control and protection system which comprises the following equipment:
- Swing rack type protective relay switchboard
  - Transducer panels
  - Interposing relay panels
  - Marshalling panels for the remote terminal unit
  - Marshalling panels for the fault recording system
  - Marshalling panels for the control system
  - Marshalling panels for the teleprotection interface
  - EGAT-PEA interfacing panels
  - Fault Recording System
  - 19" Rack type panel for GPS Receiver Panel
  - Outdoor GPS receiver system
  - 400/230 VAC, 125 VDC power panel and distribution boards
  - Loose equipment as specified in price schedules
  - Cable and accessories as well as connection of cables among all the new panels and the associated equipment in order to complete the function of the control and protection system.

10. Design, installation, wiring, test and commissioning of Remote Terminal Units (RTUs) and Master Station Unit which are supplied by EGAT. However, configuration that is included in this contract shall be fulfilled under EGAT's supervision.
11. Installation of the application software, database, control function and display for the Computerized Control System which the application software is supplied by EGAT. The installation shall be under EGAT's supervision.
12. Design, supply, installation, wiring, test and commissioning of Ethernet switch which is connected between protection relays and EGAT's Operation LAN.
13. Laying of optical fiber cable with accessories between EGAT-PEA interfacing panel at Control building to joint box at 115 kV Line No.1,2 and 3 to PEA take-off structure. (including field testing for optical fiber)
14. Design, supply, installation, wiring, test and commissioning of GPS receiver which are used as a reference time base to control and protection equipment.
15. The Contractor shall be responsible for providing complete schematic and wiring diagrams of the control and protection systems.

#### **CCTV system**

16. Design, supply, and installation of the substation CCTV system which complies with the following qualifications:
  - 16.1 The system can be operated 24 hours a day.
  - 16.2 All cameras in the system shall be IP-camera type.
  - 16.3 At least 2 monitoring locations are required, the guardhouse and the control room.
  - 16.4 Installation space in the control room shall be prepared for rack cabinet(s) and CCTV operation desk(s) positions.
  - 16.5 In case of outdoor installation, all devices shall be weather-proof type which can be operated in all outdoor weather conditions, robust and durable.
  - 16.6 The bidder or a subcontractor shall be authorized by a representative or a branch office of manufacturer in Thailand.
  - 16.7 The bidder or a subcontractor shall be able to supply the spare parts of CCTV equipment in this contract for at least five (5) years starting from the date of EGAT acceptance.
  - 16.8 The calculation and required drawing according to the attached Bidding Document Specification shall be submitted to EGAT for approval.

## **Civil and Architectural Work**

### **17. Design and construction of**

#### **17.1 230 kV GIS building which comprises at least the following :**

- 17.1.1 Structure & foundation. The proper structure can be selected for the design and construction and shall be submitted to EGAT for approval.
- 17.1.2 RC and/or steel structure for roof.
- 17.1.3 Fire protection for steel structure shall conform to legal provision, EGAT's specifications and Design manual for substation. Therefore, Fire protection for steel structure specification in Architecture drawing shall be cancelled.
- 17.1.4 Architectural of the whole building.
- 17.1.5 The contractor shall construct the building conformed to "IEEE STD-979- 1994 (R2004)" (IEEE Guide for Substation Fire Protection).
- 17.1.6 230 kV GIS buildings shall be designed with reference to Dwg. No. SD-GIS-8-01A. But equipment layouts shall conform to electrical drawing (Dwg. No. SE-GIS-0-01-01/01 and Dwg.No.CB2-S-2). Other facilities layouts shall conform to requirements with reference to architectural drawings and scope of work.
- 17.1.7 Size of 230 kV GIS building can be selected for the design and shall be submitted with the proposal in the bidding process.
- 17.1.8 The design of building shall analyze and take the following aspects into consideration: Site, Environment, Context, Function, Climate (sunlight, wind, rain, heat etc.), Energy efficiency, Safety and including aesthetic of architecture to encourage EGAT corporate identity.
- 17.1.9 Electricity and illumination system including cable work for illumination, ventilation system and power supply.
- 17.1.10 Plumbing system for water supply, building drain, vent and storm drain system.
- 17.1.11 Miscellaneous including grounding and labeling.
- 17.1.12 Cable routing and cable support (Cable tray and Cable ladder) installed in cable room and main cable trench.
- 17.1.13 Overhead traveling crane with wireless crane remote control of lifting capacity not less than 7.5 metric tons. Overhead traveling crane shall have cat-walk for maintenance the equipment on ceiling.
- 17.1.14 Signboard on building and room name sign on each room.
- 17.1.15 Warning sign provided in accordance with EIT Standard or Quality and Safety Development Division Standard (EGAT).

17.2 Fire protection system for 230 kV GIS Building.

17.2.1 GIS Building shall consist of video image smoke detector system, optical beam smoke detector and aspirated smoke detector.

17.2.2 Fire protection system of GIS Building shall have trouble and operation visual and audible signals (environmental monitoring), which indicate change of state of any connected device, shown and recorded at control room in 230 kV Control Building. The installation practice shall be in accordance with the last edition of NFPA 72.

17.2.3 There shall be sounder and beacon on the roof of the building.

17.2.4 For air sampling smoke detector as shown on specification 3001-10.13.2 part i item no.1, 7, 13 and 14 shall be changed to the new details as followings :

i. Air Sampling Smoke Detector.

(1) Shall consist of a high sensitivity type detector, using light scatter technology.

(7) Detection system must be included in all control cabinet and can locate a scene.

(13) The minimum sensitivity settings for a single sampling hole are so that the detection system alarm at 1.5% obs/ft (4.95% obs/m). A sampling hole maximum coverage area is 400.0 sq.ft (37.2 sq.m).

(14) Maximum transport time from the most remote port to the detection unit of an air-sampling system shall be a maximum of 90 seconds.

17.2.5 Fire protection system, fire alarm system and accessories shall be in accordance with the applicable requirements set forth in the latest edition of the following codes and standards:

- NFPA 70 : National Electrical Code.
- NFPA 72 : National Fire Alarm Code.
- NFPA 75: Standard for the Fire Protection of Information Technology Equipment.
- NFPA 76 : Standard for the Fire Protection of Telecommunications Facilities.
- EGAT's Standard Design Manual of Fire Protection and Suppression for Substation.(คู่มือมาตรฐานการออกแบบเพื่อป้องกันและระงับอัคคีภัยสถานีไฟฟ้าแรงสูงการไฟฟ้าฝ่ายผลิตแห่งประเทศไทย)
- IEEE Std 979: IEEE Guide for Substation Fire Protection

- NFPA 850: Recommended Practice for Fire Protection for Electric Generating Plants and High Voltage Direct Current Converter Substations

### 17.3 230/115 kV Control Building.

- 17.3.1 Fire protection for steel structure shall conform to legal provision, EGAT's specifications and Design manual for substation. Therefore, Fire protection specification in Architecture drawing shall be cancelled.
- 17.3.2 Architecture of the whole building.
- 17.3.3 The contractor shall construct the building in accordance with "IEEE STD- 979-1994 (R2004)" (IEEE Guide for Substation Fire Protection).
- 17.3.4 230/115 kV Control Building shall be designed with reference to Dwg. No. SD-CD-0-02A. Equipment layouts **and cable block outs** shall conform to electrical drawing (Dwg.No.TYP2A-S-6). Other facilities layouts shall conform to requirements with reference to architectural drawings and scope of work.
- 17.3.5 Electricity and illumination system including cable work for illumination, ventilation system, power supply, air conditioning system, and telephone system.
- 17.3.6 Plumbing system for water supply, building drain and vent, storm water drainage including sanitary wares and fittings.
- 17.3.7 Miscellaneous including grounding and labeling.
- 17.3.8 Cable routing and cable support (cable tray and cable ladder) installed in cable room and main cable trench.
- 17.3.9 Signboard on building and room name sign on each room.
- 17.3.10 **Access floor system or Raised flooring system (For walking area)**
  - **Panels shall be capable of supporting a uniform load or distributed load not less than 1,500 kg/sq.m.**
  - **Floor panels shall consist of calcium sulphate have protection against humidity, rotting and fire. Panels shall be jig-milled to thickness size.**
    - \*Thickness : not less than 35 mm.**
    - \*Module : 600x600 mm. or 24x24 Inches**
  - **Finish the surface of the floor panels with floor covering material indicated mineral panels with High Pressure Laminated (HPL) shall be not less than 1.5 mm. from manufacturer standard.**
  - **Panels material shall be non-combustible, fire retardant, or the fire resistant building material class A, with galvanized steel plate covering both on the top and bottom of the panel.**

- *The understructure system of access floor such as pedestal profile, Stringer, head plate and steel bolt shall be made of Electroplated Galvanized Steel (ASTM A879)*
- *The system frame area which are fixed to the current system by bolting and adhesive shall be unwelded connection.*
- *The access floor system, following standard :*
  - \*Load test : EN 12825 or CISCA*
  - \*Fire test : DIN4102 : F30 A or ASTM E84 Class A or BS476 part 4 Class A*
- *The test report shall be certified by a third party accredited laboratory.*
- *The pattern of access floor (Walking area) relating to cable route and equipment layout shall be submitted to EGAT for approval.*
- *All components of access floor system, which consist of floor panel, stringer, pedestal, and other part, shall be manufactured by the same manufacturer.*
- *With 10 years guarantee of material and 2 years installation.*

*The access floor system material in the Specification No.3001 (Civil and Architectural work) No.3001-10.8.3.5 Access Floor System (Raised Flooring System) and the referenced drawings of the said material shall be cancelled.*

17.3.11 Warning sign provided in accordance with EIT Standard or Quality and Safety Development Division Standard (EGAT).

17.3.12 Furniture as specified in Architectural Drawings not included in this contract except as the following :

- Complete set of pantry storage side board that consists of base cabinet and wall hanging cabinet, including one stainless sink tap and full set of pantry accessories.

17.4 Fire protection system for 230 kV Control Building.

17.4.1 Control Building shall consist of Total Flood Clean Agent Fire Suppression System with heat detector, addressable type smoke detector and aspirated smoke detector.

17.4.2 Fire protection system of Control Building shall have trouble and operation visual and audible signals (environmental monitoring), which indicate change of state of any connected device, shown and recorded at control room in 230 kV Control Building. The installation practice shall be in accordance with the last edition of NFPA 72.

17.4.3 There shall be sounder and beacon on the roof of the building.

17.4.4 For system requirements for indoor fire protection system as shown on specification 3001-10.13.1 part e, item no.1 and 6 shall be changed to the new details as follow:

(1) System description and operation : Supply and Installation of a Total Flood

Clean Agent Fire Suppression System utilizing IG-100 shall cover all these zones :

Zone 1: Equipment (Control/Relay) Room;

Zone 2: Electrical Room;

Zone 3: Under Raised Floor (If Required);

Zone 4: Battery Room;

Zone 5: Cable Room (If required);

Zone 6: Inert Gas Room

Other zone (If required)

Each protected zone shall have its own set of IG-100 cylinders.

(6) Detectors shall be cross-zoned detection requiring 2 detectors to be in alarm before discharge. A zone of A or B of addressable smoke detector and a zone C of all ASD shall be crossed.

17.4.5 For air sampling smoke detector as shown on specification 3001-10.13.2 part i item no.1, 7, 13 and 14 shall be changed to the new details as followings :

i. Air Sampling Smoke Detector.

(1) Shall consist of a high sensitivity type detector, using light scatter technology.

(7) Detection system must be included in all control cabinet and can locate a scene.

(13) The minimum sensitivity settings for a single sampling hole are so that the detection system alarm at 1.5% obs/ft (4.95%

obs/m). A sampling hole maximum coverage area is 400.0 sq.ft (37.2 sq.m).

(14) Maximum transport time from the most remote port to the detection unit of an air-sampling system shall be a maximum of 90 seconds.

17.4.6 Fire protection system, fire alarm system, installation room and accessories shall be in accordance with the applicable requirements set forth in the latest edition of the following codes and standards:

- NFPA 2001: Clean Agent Fire Extinguishing Systems.
- NFPA 70 : National Electrical Code.
- NFPA 72 : National Fire Alarm Code.
- NFPA 75 : Standard for the Fire Protection of Information Technology Equipment.
- NFPA76 : Standard for the Fire Protection of Telecommunications Facilities.
- EGAT's Standard Design Manual of Fire Protection and Suppression for Substation.(คู่มือมาตรฐานการออกแบบเพื่อป้องกันและระงับอัคคีภัยสถานีไฟฟ้าแรงสูงการไฟฟ้าฝ่ายผลิตแห่งประเทศไทย)
- IEEE Std 979: IEEE Guide for Substation Fire Protection
- NFPA 850: Recommended Practice for Fire Protection for Electric Generating Plants and High Voltage Direct Current Converter Substations.

17.4.7 There shall be one control panel for fire detection system and IG-100 fire suppression system for each room which is protected by the IG-100 fire suppression system.

17.4.8 There shall be a protective clear polycarbonate cover which can be immediately lifted or opened for all IG-100 manual release stations.

17.5 Fire protection system for the switchyard to meet the requirement as specified in IEEE Guide for Substation Fire Protection: IEEE Std 979, all requirements of NFPA 850 and EGAT's Standard Design Manual of Fire Protection and Suppression for Substation(คู่มือมาตรฐานการออกแบบเพื่อป้องกันและระงับอัคคีภัยสถานีไฟฟ้าแรงสูงการไฟฟ้าฝ่ายผลิตแห่งประเทศไทย).

17.6 Fire protection system for the Transformer : The Foam-water spray system shall comply with the following;

- 17.6.1 Foam-water spray system: NFPA 13, NFPA16 & NFPA 850
- 17.6.2 Bladder tank vessel construction standards : Carbon steel to ASME code section VIII for unfired pressure vessel.
- 17.6.3 Nozzles : NFPA 16 and as per Manufacturer's Recommendation
- 17.6.4 Detection system : Air Expansion Linear Heat Detection System (LHB)
- 17.6.5 Equipment for system : FM approved, UL Listings , Vds

197



- 17.6.6 EGAT's Standard Design Manual of Fire Protection and Suppression for Substation. (คู่มือมาตรฐานการออกแบบเพื่อป้องกันและระงับอัคคีภัยสถานีไฟฟ้าแรงสูงการไฟฟ้าฝ่ายผลิตแห่งประเทศไทย)
- 17.6.7 Foam-water spray system provided for Transformer shall be designed for a density of 10.2 litre/min-sq.m over the exposed surface at the Transformer.
- 17.6.8 There shall be one linear heat detector box for each transformer.
- 17.6.9 There shall be one control panel for fire detection system and foam/water spray system for each transformer which is protected by the foam/water spray system.
- 17.7 ASD system for cabinets shall be able to alarm and address the source of smoke within 60 seconds and no later than transport time of ASD of each cabinet.
- 17.8 Fire Pump System. (conforming to NFPA 14, 20, 22, 24, 72).
- 17.9 250 cu.m. water storage tank, fire pump, and jockey pump shall have trouble and operation visual and audible signals (environmental monitoring), which indicate change of state of any connected devices, shown and recorded at control room in 230/115 kV GIS and Control/Relay Building. The installation practice shall be in accordance with the latest edition of NFPA 72.
- 17.10 There shall be one fire alarm system graphic annunciator at each building to enable responding personnel to identify the location of a fire accurately and to indicate the status of emergency equipment or fire safety functions.
- 17.11 There shall be one graphic annunciator which displays alarm, discharge and trouble signals of fire alarm system of other buildings, (fire pump houses, transformers, shunt reactors) at the building where control room locates
- 17.12 Fire protection system circuits for buildings and switchyards : notification appliance circuits , and signaling line circuits , shall be class A circuit. Initiating device circuits can be class B circuit.
- 17.13 For Control System Logic as shown on specification 3001-13.4 item 4.1 shall be changed to the new detail as following
- (4.1) In case of fire, heat detector and the tubular expansion detector first give alarm. If rate of rise/fixed temp in heat detector/tubular expansion detector sense fire condition, there shall be alarm in control room and the detected transformer shall be tripped before applying Foam-Water spray as the condition shown in the diagram below ;

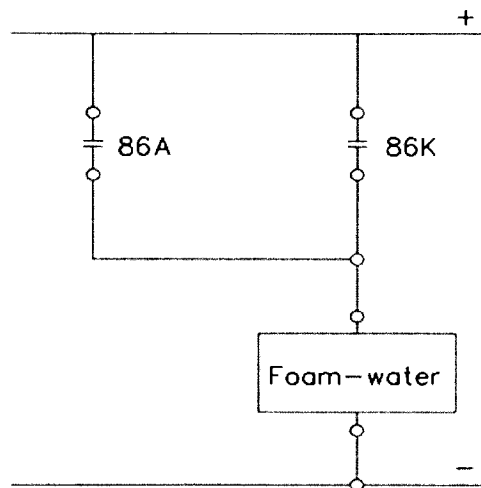

17.14 Signals of indoor fire protection system of each room and signals of outdoor fire protection system of each transformer shall be sent to local CCS, GCC, RCC, and NCC as following details;

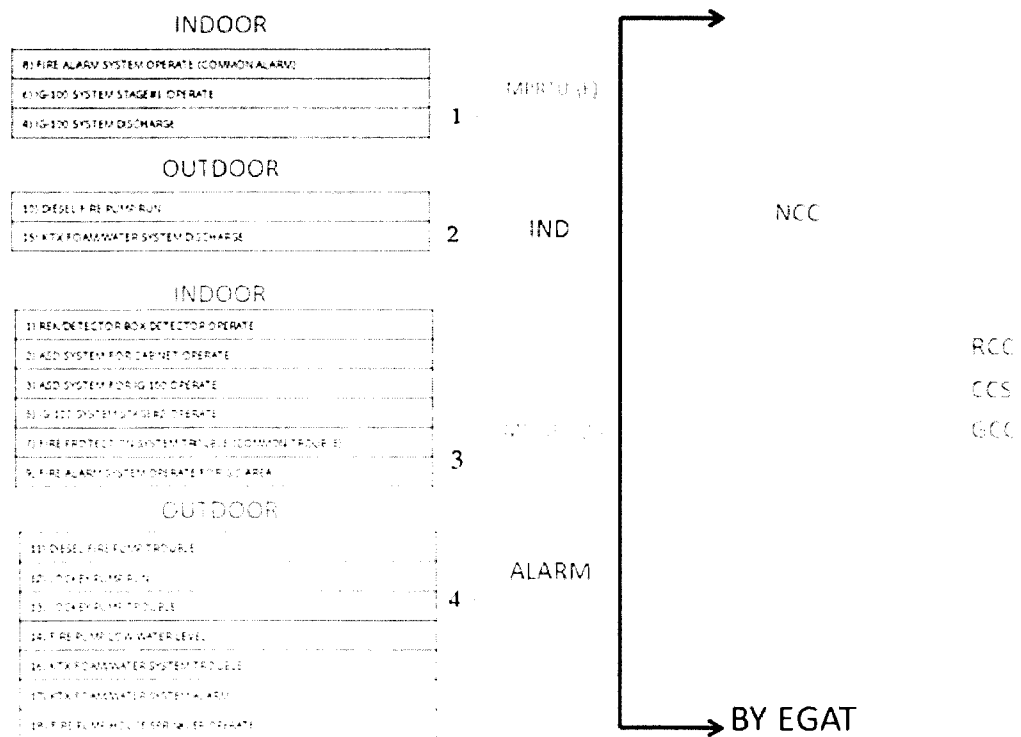

17.15 There shall be only one subcontractor engaging in design, supply and installation of Fire Protection System for Buildings and Switchyard.

17.16 Water supply system.

17.17 All building wall openings for fire protection dampers shall be provided with stainless steel louvers and insect screens to install inside of building.

17.18 Design and construction required for a complete 230 kV Gas Insulated substation (GIS) which comprises at least the following :

17.18.1 GIB & GIS bushing structure and foundation.

17.18.2 Specified equipment and steel structure foundations and the others not shown in "For Construction drawings" and /or EGAT's specification.

17.18.3 Road, drainage system and drainage system for cable trench.

17.18.4 Cable tray for transformer, underground cable in HDPE duct.

17.19 For portable fire extinguisher as shown on specification 3001- 10.13.3 shall be changed to the new details as followings :

- The fire extinguishers shall be conformed to latest TIS standards. The portable and mobile fire extinguishers shall be carbon dioxide (CO<sub>2</sub>) conforming to TIS 881 and/or dry chemical conforming to TIS 332 , capacity 10 lbs/set. The fitting accessories shall be provided.

- The portable fire extinguishers shall be installed according to the latest NFPA 10 and the latest EGAT's Standard of Fire Suppression for Substation. (ระเบียบการไฟฟ้าฝ่ายผลิตแห่งประเทศไทยฉบับที่107ว่าด้วย "มาตรฐานระบบดับเพลิง สถานีไฟฟ้าแรงสูง").

17.20 For safety sign of fire protection system shall be conformed to EGAT's Safety Sign Standard. (ระเบียบการไฟฟ้าฝ่ายผลิตแห่งประเทศไทยฉบับที่100ว่าด้วย "มาตรฐานเครื่องหมายความปลอดภัย")

17.21 Fire protection system work shall be inspected and maintained for 2 years, not less than 4 times per year and not less than manufacturers' recommendation.

17.22 There shall be a set of computer desk with chair, a set of CPU which suitable for fire protection system software and operate 24 hours a day and a set of 24" LED monitor which show the status of fire protection system in control room in 230/115 kV Control Building. If there is any video image smoke detector in GIS area, there shall be one more monitor which shows the detecting zone of each video image smoke detector. One set of laser jet printer shall be provided.

## 18. Construction of

18.1 Transformer loading and Dead man hook for loading transformer.

18.2 Wire mesh fence.

18.3 Crushed rock surfacing.

18.4 Cable trench.

18.5 Lamp post for fence and access road lighting LED type foundation.

18.6 Water storage tank for fire protection system (capacity not less than 250 cu.m.)

18.7 Foam house and accessories.

18.8 Fire pump house.

- 18.9 Underground water tank **24** cu.m.
- 18.10 Water tank tower 15 cu.m.
- 18.11 Cabinets with 2 sets of 50 lbs wheel fire extinguisher.
- 18.12 CO2 Portable fire extinguishers shall be UL listed or FM approved.
- 18.13 Oil pit with black steel spiral-seam pipes (TIS 427-2531) with protection method according to AWWA C217, C205.
- 18.14 Oil separator.
- 18.15 Site office
- 18.16 Garage house 5.50 x 12.00 m (4 cars).
- 18.17 Equipment support structure foundation.
  
19. The drawings and calculation of all building shall be verified with adequate details for intended application and submitted to EGAT for approval.
20. All design works and the fabrication drawings for all steel structures shall be submitted to EGAT for approval.
21. All design, construction and testing shall conform to Specification No.3001 : Civil and Architectural Work.
22. EGAT's Soil Investigation Report attached to the Contract is a document that can be a reference for design, however; the review of the soil investigation report shall be under responsibility of the Contractor and the warranty of work shall remain following all obligations as specified in the Contract.
23. All foundations shall be as specified on lay out drawing except the result of soil investigation shows that the specified foundations are not appropriate, the Contractor shall design the proposed foundations.
24. The contract price will be adjusted (added or reduced) in case that the soil investigation results to be used for the design works is different from the lay out and standard drawings.
25. The Contractor shall remove all debris from construction material and other work in order to make the site clean and be in the condition acceptable to EGAT.
26. Three minutes 3D animation presentation file (MP4, resolution not less than 1440 p; 2500 X 1440) demonstrating details of switchyard and interior and exterior buildings shall be arranged, with reference to Substation 3D Animation.mp4 attached file.
27. According to the Contract Document Section G-3 : Contractor's Office and Other Construction Facilities; the detail in paragraph 3 shall be changed as follows : the Contractor shall provide for EGAT an office container at the site during construction with a minimum space of 36 square meters for office area, 24 square meters for conference room which shall both be air-conditioned and 4 square meters for toilet. The facilities as shown on the section G-3 are required for two sets.

28. Dynamic load test (DLT) according to ASTM D4945-89 shall be applied to at least 2% of driven piles (if driven pile type is required) except for driven pile of fence and lamp post.
29. Seismic load test (sonic integrity test) according to ASTM D5882-96 shall be applied to all bored piles (if bored pile type is required).
30. Plate bearing test according to ASTM D1194-94 shall be submitted to EGAT for approval.(if pad type foundation is required).

**Work not included in this Contract** The Work not included in this Contract shall be as shown on the drawings and as follows:

1. Supply and installation of 230/115-22 kV auto-transformers “KT1A, KT2A, KT3A.
2. The stringing work for the connection between the 230 kV & 115 kV substation take-off structures and the dead-end towers of the transmission lines.
3. The stringing work for the connection between the 115 kV take-off structures and WSDE towers for 115 kV line to PEA No.1, No.2 and No.3.
4. Supply of suspension insulators and post insulators.
5. Supply of Remote Terminal Units (RTUs), Master Station Unit and application software.

## **2. 230 KV BO WIN SUBSTATION (BWN) (Job No. TS12-11-S12)**

### **General**

The existing 230/115 kV Bo Win Substation is located at Tumbon Bowin, Si Racha District and Chon Buri Province. The work for Bo Win Substation is a supply and construction of the extended three (3) bays of Breaker & a half scheme to provide for 230 kV lines to Chon Buri 2 substation, 230 kV line to Ban Bung 2 substation and 230 kV line to Bo Win Power Plant.

### **Schedule 2**

The existing Bo Win Substation shall consist of 230/115 kV Conventional Substation (AIS) and the bus arrangement shall be Breaker and a half scheme, the extended three (3) bays consists of as follows:

1. 2 bays (two) for 230 kV line No.1&2 to Chon Buri 2 Substation.
2. 1 bay (one) for 230 kV line No.1 to Bo Win Power Plant.
3. Additional middle row equipment of Breaker and a half scheme for 230 kV line No.1 to Ban Bung 2 Substation.

The Contractor shall supply equipment, perform construction and installation work necessary for completion of operation substation in accordance with the Contract Documents. The design work shall include, but not limited to, technical calculation, preparation of drawings, bill of materials for installation and construction work. For accomplishment of complete operational substation, Scope of Contractor's work shall include connection to all public utilities i.e. electrical power, water and drainage. Testing and commissioning of all equipment required to make the substation function properly.

Besides, all detailed engineering design work, calculations, drawing preparation, submission of backup data, test reports, instruction books (and), etc. shall be included.

1) As stated elsewhere in this bidding documents, the drawings included in the bidding documents except drawing mark "For Construction" are for bidding purposes only and shall not be used for execution of the work.

2) The submitted drawings which are incomplete/unacceptable, or are the bidding document copies with minor modifications shall be returned unmarked to the Contractor.

3) The drawings shall be furnished which provide all details required for thoroughly described equipment as well as installation methods and requirements. However, EGAT retains the right to request additional details if those furnished are perceived inadequate.

4) Calculations, backup data and documentation are required for all parts of the design. The furnished data shall verify completely that design is adequate for application purpose.

**Work included in this Contract.** The Work included in this Contract to be performed by the Contractor shall be as specified in the Contract Documents and as follows:

**For Electrical Work**

**1. 230 kV AIS**

- 1.1 Design, supply, and installation of equipment are required for a complete 230 kV AIS type substation.
- 1.2 Installation of 21 sets of 230 kV current transformers (QZ1A, QZ1C, QZ2A, QZ2C, QZ8B, QZ9A, QZ9C) and the said current transformers and its steel structures are supplied by EGAT.
- 1.3 Installation of 9 sets of 230 kV coupling capacitor voltage transformers (VZ1B, VZ2B, VZ8B) and the said coupling capacitor voltage transformers and its steel structures are supplied by EGAT.
- 1.4 Installation of 4 sets 230 kV Circuit Breakers (80132, 80212, 80822, 80912), and the said Circuit Breakers and its steel structures are supplied by EGAT.
- 1.5 Installation of 230 kV post insulators and 230 kV suspension insulators. Both insulators are supplied by EGAT.
- 1.6 Design, supply and installation of all miscellaneous hardware for 230 kV post insulators, 230 kV suspension insulators.

**2. Grounding system**

- 2.1 Design, supply, and installation of the equipment grounding of 230/115 kV substation grounding system.
- 2.2 Design, supply and installation of riser conductors for additional 230 kV equipment grounding system.
- 2.3 The 40 kA fault current shall be used for determining the size of grounding conductors for the substation grounding system. The said grounding conductor for the substation grounding system shall be the 4/0 AWG bare copper wire type.
- 2.4 Supply and installation of additional ground grid conductors for the improvement of existing grounding system as shown on dwg.no.BWN-S-5 sh.01/02, 02/02 and the additional ground grid shall be connected to the existing which their every across points.
- 2.5 Supply and add up the of 0.10 meter of the additional top surface crush rock for improvement of existing grounding system (4050 m<sup>3</sup> approx.)
- 2.6 The thick of surface crush rock for additional grounding system shall be 0.15 meter.



### **3. Lightning protection system**

- 3.1 Design, supply, and installation of a substation lightning protection system shall complete with all related equipment. The Contractor shall design the lightning protection system to protect all Substation Equipment which is under the protective zone. To meet EGAT's design criteria for lightning protection and to enhance stability of the protection system, the Basic Insulation Level voltage (BIL) is to be used in calculation instead of Critical Flashover voltage (CFO) which is 900 kV shall be used for 230 kV substation.

### **4. Facility system**

- 4.1 Design, supply, and installation of a substation lighting system shall complete with all integral accessories to provide a complete system operation. The lighting system mainly consists of equipment lighting, fence lighting, raceways and cables for lighting circuits.
- 4.2 The size of low voltage cable shall be sufficient to keep the voltage drop occurring at the load point to be less than 5 percent at the rated load current.
- 4.3 Before re-installation seven (7) sets of the lamp posts and the fence lighting fixtures, the said equipment and accessories shall be checked and cleaned or replaced the damaged parts with new ones to be in a good operation by the Contractor.

### **5. Other work**

- 5.1 Design, supply, and installation of Feeder names or Identification Plate as well as phasing and switching numbers.
- 5.2 Testing and commissioning of all equipment are required to make the substation function properly.

### **Control and Protection System**

6. Design, supply, installation, wiring, test and commissioning of the complete control and protection system which comprises the following equipment:
  - Swing rack type protective relay switchboard
  - Transducer panels
  - Interposing relay panels
  - Marshalling panels for the remote terminal unit
  - Marshalling panels for the fault recording system
  - Marshalling panels for the control system
  - Marshalling panels for the teleprotection interface
  - Fault Recording System

- 19" Rack type panel for GPS Receiver Panel
  - Outdoor GPS receiver system
  - 400/230 VAC and 125 VDC distribution boards
  - Loose equipment as specified in price schedules
  - Cable and accessories as well as connection of cables among all the new panels, the existing panels and the associated equipment in order to complete the function of the control and protection system.
7. Design, modification, wiring, test and commissioning of the existing control and protection system which comprises the following equipment:
    - Swing rack type protective relay switchboard
    - Marshalling panels for the remote terminal unit
    - Marshalling panels for the fault recording system
    - Marshalling panels for the teleprotection interface
    - Fault Recording System
    - Remote Terminal Units
    - 400/230 VAC, 125 VDC power panel and 125 VDC distribution boards
  8. Design, installation, wiring, test and commissioning of Remote Terminal Units (RTUs) and database which are supplied by EGAT. However, configuration that is included in this contract shall be fulfilled under EGAT's supervision.
  9. Design, supply, installation, wiring, test and commissioning of Ethernet Switch which is connected between the protection relays supplied under this Contract and EGAT's operation LAN
  10. Design, supply, installation, wiring, test and commissioning of GPS receiver which are used as a reference time base to control and protection equipment.
  11. Any modification and interfacing works to the existing metering, control and protection panels, including supply of related accessory equipment which is required for incorporating the new equipment. The modified existing drawings shall be performed by the Contractor and submitted to EGAT for approval. The final drawings shall be submitted as ACAD files.
  12. The Contractor shall be responsible for providing complete schematic and wiring diagrams of the control and protection systems.
  13. Removal of the unused existing cables. The removed cables shall be neatly reeled and kept in a suitable place recommended by EGAT.

**Civil and Architectural Work**

14. Design and construction of

14.1 Modification of the existing Control Building.

- 14.1.1 Modified existing Control building structure to support control panel with Equipment layouts shall conform to electrical drawing (Dwg.No.BWN-S-6). Other facilities layouts shall conform to requirements with reference to architectural drawings and scope of work.
  - 14.1.2 Miscellaneous including grounding and labeling.
  - 14.1.3 Cable routing and cable support (cable tray and cable ladder) installed in cable room and main cable trench.
- 14.2 Modification of the existing Control Building for installation of fire protection system.
- 14.2.1 Modify AHU Room in an existing Control Building to support Inert Gas Room. (LL  $\geq$  1200 kg/sq.m)
  - 14.2.2 Modify ceiling, door and window system of Control Room, Battery Room and AHU Room in an existing 230 kV Control Building to support fire protection system.
- 14.3 Fire protection system for 230 kV Control Building.
- 14.3.1 Control Building shall consist of Total Flood Clean Agent Fire Suppression System with heat detector, addressable type smoke detector and aspirated smoke detector.
  - 14.3.2 Fire protection system of 230 kV Control Building shall have trouble and operation visual and audible signals (environmental monitoring), which indicate change of state of any connected device, shown and recorded at control room in 230 kV Control Building. The installation practice shall be in accordance with the last edition of NFPA 72.
  - 14.3.3 There shall be sounder and beacon on the roof of the building.
  - 14.3.4 For system requirements for indoor fire protection system as shown on specification 3001-10.13.1 part e, item no.1 and 6 shall be changed to the new details as follow
    - (1) System description and operation : Supply and Installation of a Total Flood Clean Agent Fire Suppression System utilizing IG-100 shall cover all these zones :
      - Zone 1: Equipment (Control/Relay) Room ;
      - Zone 2: Electrical Room ;
      - Zone 3: Under Raised Floor (If Required);
      - Zone 4: Battery Room ;
      - Zone 5: Cable Room (If required) ;
      - Zone 6: Inert Gas Room
      - Other zone (If required)
- Each protected zone shall have its own set of IG-100 cylinders.

- (6) Detectors shall be cross-zoned detection requiring 2 detectors to be in alarm before discharge. A zone of A or B of addressable smoke detector and a zone C of all ASD shall be crossed.
- 14.3.5 For air sampling smoke detector as shown on specification 3001- 10.13.2 part i item no.1, 7, 13 and 14 shall be changed to the new details as followings :
- i. Air Sampling Smoke Detector.
- (1) Shall consist of a high sensitivity type detector, using light scatter technology.
  - (7) Detection system must be included in all control cabinet and can locate a scene.
  - (13) The minimum sensitivity settings for a single sampling hole are so that the detection system alarm at 1.5% obs/ft (4.95% obs/m). A sampling hole maximum coverage area is 400.0 sq.ft (37.2 sq.m).
  - (14) Maximum transport time from the most remote port to the detection unit of an air-sampling system shall be a maximum of 90 seconds.
- 14.3.6 Fire protection system, fire alarm system, installation room and accessories shall be in accordance with the applicable requirements set forth in the latest edition of the following codes and standards:
- NFPA 2001: Clean Agent Fire Extinguishing Systems.
  - NFPA 70 : National Electrical Code.
  - NFPA 72 : National Fire Alarm Code.
  - NFPA 75 : Standard for the Fire Protection of Information Technology Equipment.
  - NFPA76 : Standard for the Fire Protection of Telecommunications Facilities.
  - EGAT's Standard Design Manual of Fire Protection and Suppression for Substation.(คู่มือมาตรฐานการออกแบบเพื่อป้องกันและระงับอัคคีภัยสถานีไฟฟ้าแรงสูงการไฟฟ้าฝ่ายผลิตแห่งประเทศไทย)
  - IEEE Std 979: IEEE Guide for Substation Fire Protection
  - NFPA 850: Recommended Practice for Fire Protection for Electric Generating Plants and High Voltage Direct Current Converter Substations.
- 14.3.7 There shall be one control panel for fire detection system and IG-100 fire suppression system for each room which is protected by the IG-100 fire suppression system.
- 14.3.8 There shall be a protective clear polycarbonate cover which can be immediately lifted or opened for all IG-100 manual release stations.

- 14.4 Fire protection system for the switchyard to meet the requirement as specified in IEEE Guide for Substation Fire Protection: IEEE Std 979, all requirements of NFPA 850 and EGAT's Standard Design Manual of Fire Protection and Suppression for Substation (คู่มือมาตรฐานการออกแบบเพื่อป้องกันและระงับอัคคีภัยสถานีไฟฟ้าแรงสูงการไฟฟ้าฝ่ายผลิตแห่งประเทศไทย).
- 14.5 Fire Pump System. (conforming to NFPA 14, 20, 22, 24, 72).
- 14.6 250 cu.m water storage tank, fire pump, and jockey pump shall have trouble and operation visual and audible signals (environmental monitoring), which indicate change of state of any connected devices, shown and recorded at control room in 500/230/115 kV GIS and Control/Relay Building. The installation practice shall be in accordance with the latest edition of NFPA 72.
- 14.7 There shall be one graphic annunciator which displays alarm, discharge and trouble signals of fire alarm system of other buildings, (fire pump houses, transformers, shunt reactors) at the building where control room locates.
- 14.8 Fire protection system circuits for buildings and switchyards : notification appliance circuits , and signaling line circuits , shall be class A circuit. Initiating device circuits can be class B circuit.
- 14.9 Signals of indoor fire protection system of each room and signals of outdoor fire protection system of each transformer shall be sent to local CCS, GCC, RCC, and NCC as following details;

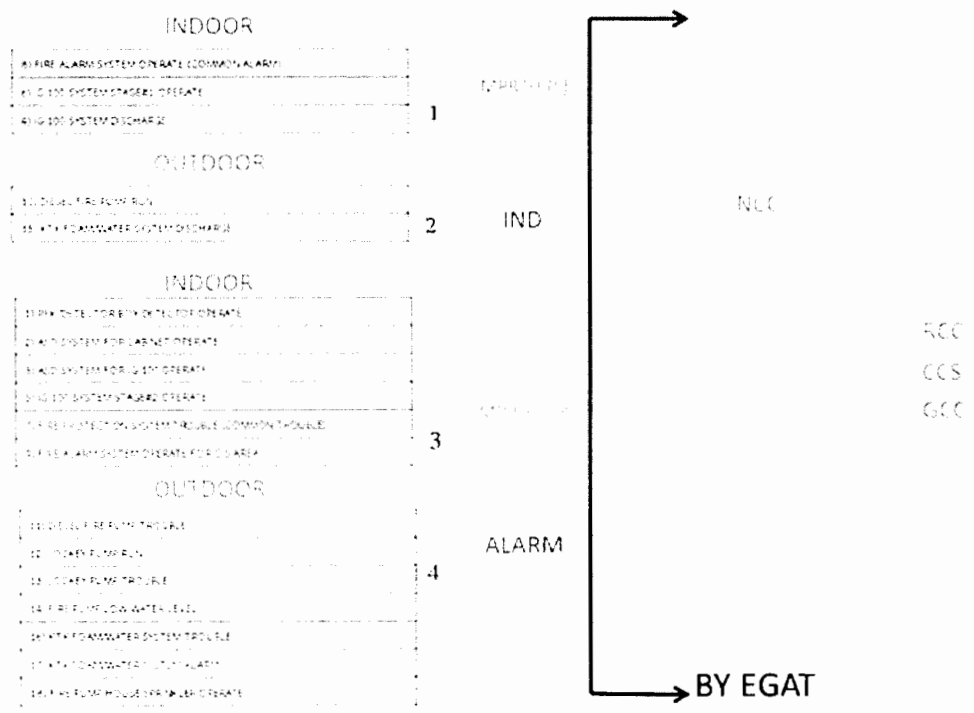

14.10 There shall be only one subcontractor engaging in design, supply and installation of Fire Protection System for Buildings and Switchyard.

14.11 Water supply system.

14.12 All building wall openings for fire protection dampers shall be provided with stainless steel louvers and insect screens to install inside of building.

14.13 For portable fire extinguisher as shown on specification 3001- 10.13.3 shall be changed to the new details as followings :

- The fire extinguishers shall be conformed to latest TIS standards. The portable and mobile fire extinguishers shall be carbon dioxide (CO2) conforming to TIS 881 and/or dry chemical conforming to TIS 332 , capacity 10 lbs/set. The fitting accessories shall be provided.
- The portable fire extinguishers shall be installed according to the latest NFPA 10 and the latest EGAT's Standard of Fire Suppression for Substation. (ระเบียบการไฟฟ้าฝ่ายผลิตแห่งประเทศไทย ฉบับที่ 107 ว่าด้วย "มาตรฐานระบบดับเพลิง สถานีไฟฟ้าแรงสูง").

14.14 For safety sign of fire protection system shall be conformed to EGAT's Safety Sign Standard. (ระเบียบการไฟฟ้าฝ่ายผลิตแห่งประเทศไทย ฉบับที่ 100 ว่าด้วย "มาตรฐานเครื่องหมายความปลอดภัย")

14.15 Fire protection system work shall be inspected and maintained for 2 years, not less than 4 times per year and not less than manufacturers' recommendation.

14.16 There shall be a set of computer desk with chair, a set of CPU which suitable for fire protection system software and operate 24 hours a day and a set of 24" LED monitor which show the status of fire protection system in control room in 230/115 kV Control Building. If there is any video image smoke detector in GIS area, there shall be one more monitor which shows the detecting zone of each video image smoke detector. One set of laser jet printer shall be provided.

## 15. Construction of

15.1 Specified equipment and steel structure foundations and the others not shown in "For Construction drawings" and /or EGAT's specification.

15.2 Road, drainage system and drainage system for cable trench.

15.3 Wire mesh fence.

15.4 Crushed rock surfacing.

15.5 Cable trench.

15.6 Lamp post for fence and access road lighting LED type foundation.

15.7 Cabinets with 2x50 lbs wheel fire extinguisher.

15.8 Water storage tank for fire protection system (capacity not less than 250 cu.m).

15.9 Fire pump house.

#### 15.10 Site office

16. The drawings and calculation of all building shall be verified with adequate details for intended application and submitted to EGAT for approval.
17. All design works and the fabrication drawings for all steel structures shall be submitted to EGAT for approval.
18. All design, construction and testing shall conform to Specification No.3001 : Civil and Architectural Work.
19. EGAT's Soil Investigation Report attached to the Contract is a document that can be a reference for design, however; the review of the soil investigation report shall be under responsibility of the Contractor and the warranty of work shall remain following all obligations as specified in the Contract.
20. All foundations shall be as specified on lay out drawing except the result of soil investigation shows that the specified foundations are not appropriate, the Contractor shall design the proposed foundations.
21. The contract price will be adjusted (added or reduced) in case that the soil investigation results to be used for the design works is different from the lay out and standard drawings.
22. The Contractor shall remove all debris from construction material and other work in order to make the site clean and be in the condition acceptable to EGAT.
23. Plate bearing test according to ASTM D1194-94 shall be submitted to EGAT for approval.(if pad type foundation is required).
24. According to the Contract Document Section G-3 : Contractor's Office and Other Construction Facilities; the detail in paragraph 3 shall be changed as follows : the Contractor shall provide for EGAT an office container at the site during construction with a minimum space of 36 square meters for office area, 24 square meters for conference room which shall both be air-conditioned and 4 square meters for toilet. The facilities as shown on the section G-3 are required for two sets.

**Work not included in this Contract** The Work not included in this Contract shall be as shown on the drawings and as follows:

1. The stringing work for the connection between the 230 kV substation take-off structures and the dead-end tower of the transmission lines.
2. Supply of 21 sets 230 kV current transformers with steel structures.
3. Supply of 9 sets 230 kV coupling capacitor voltage transformers with steel structures.
4. Supply of 4 sets 230 kV, 4,000A, 50 kA circuit breakers with steel structures.
5. Supply of all 230 kV suspension and post insulators.
6. Supply of Remote Terminal Units (RTUs).



3. **230 KV AO PHAISUBSTATION (AP) (Job No. TS12-11-S18)**

**Schedule 3**

**Work included in this Contract.** The Work included in this Contract to be performed by the Contractor shall be as specified in the Contract Documents and as follows:

**Control and Protection System**

1. Design, supply, installation, wiring, test and commissioning of the complete control and protection system which comprises the following equipment:
  - Loose equipment as specified in price schedules
  - Cable and accessories as well as connection of cables among all the new panels, the existing panels and the associated equipment in order to complete the function of the control and protection system.
2. Design, modification, wiring, test and commissioning of the complete control and protection system which comprises the following equipment:
  - Swing rack type protective relay switchboard
  - Marshalling panels for the remote terminal unit
  - Marshalling panels for the fault recording system
  - Marshalling panels for the control system
  - Marshalling panels for the teleprotection interface
  - Fault Recording System
  - Remote Terminal Units
  - 400/230 VAC and 125 VDC distribution boards
3. Any modification and interfacing works to the existing metering, control and protection panels, including supply of related accessory equipment which is required for incorporating the new equipment. The modified existing drawings shall be performed by the Contractor and submitted to EGAT for approval. The final drawings shall be submitted as ACAD files.
4. The Contractor shall be responsible for providing complete schematic and wiring diagrams of the control and protection systems.
5. Removal of the unused existing cables. The removed cables shall be neatly reeled and kept in a suitable place recommended by EGAT.

4. **230 KV PHAN THONGSUBSTATION (PTG) (Job No. TS12-11-S19)**

**Schedule 4**

**Work included in this Contract.** The Work included in this Contract to be performed by the Contractor shall be as specified in the Contract Documents and as follows:

**Control and Protection System**

1. Design, supply, installation, wiring, test and commissioning of the complete control and protection system which comprises the following equipment:
  - Swing rack type protective relay switchboard
  - Marshalling panels for the control system
  - Fault Recording System
  - 19" Rack type panel for GPS Receiver Panel
  - Loose equipment as specified in price schedules
  - Cable and accessories as well as connection of cables among all the new panels, the existing panels and the associated equipment in order to complete the function of the control and protection system.
2. Design, modification, wiring, test and commissioning of the existing control and protection system which comprises the following equipment:
  - Swing rack type protective relay switchboard
  - Marshalling panels for the remote terminal unit
  - Marshalling panels for the fault recording system
  - Marshalling panels for the teleprotection interface
  - Fault Recording System
  - Remote Terminal Units
  - 400/230 VAC and 125 VDC distribution boards
3. Design, installation, wiring, test and commissioning of Remote Terminal Units (RTUs) and database which are supplied by EGAT. However, configuration that is included in this contract shall be fulfilled under EGAT's supervision.
4. Design, supply, installation, wiring, test and commissioning of Ethernet Switch which is connected between the protection relays supplied under this Contract and EGAT's operation LAN.

5. Design, supply, installation, wiring, test and commissioning of GPS receiver which are used as a reference time base to control and protection equipment.
6. Any modification and interfacing works to the existing metering, control and protection panels, including supply of related accessory equipment which is required for incorporating the new equipment. The modified existing drawings shall be performed by the Contractor and submitted to EGAT for approval. The final drawings shall be submitted as ACAD files.
7. The Contractor shall be responsible for providing complete schematic and wiring diagrams of the control and protection systems.
8. Removal of the unused existing cables. The removed cables shall be neatly reeled and kept in a suitable place recommended by EGAT.

**Work not included in this Contract** The Work not included in this Contract shall be as shown on the drawings and as follows:

1. Supply of Remote Terminal Units (RTUs).